

Series Variable Displacement Piston Pumps

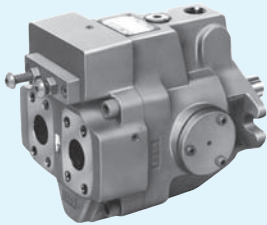

A37



A16

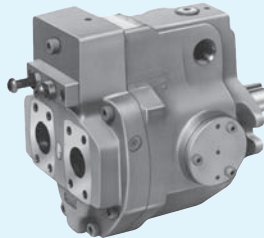

A56

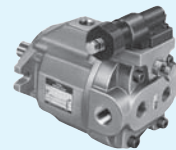

A10

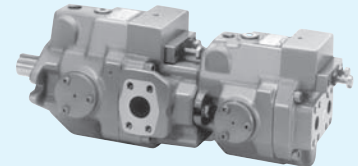

A1637

“A”Series Variable Displacement Piston Pumps

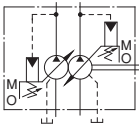
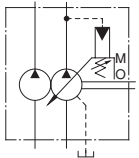
Pump Type	Graphic Symbol	Geometric Displacement cm ³ /rev							Maximum Operating Pressure MPa	Page
		1	2	5	10	20	50	100		
Single Pumps ^{★1} 		A10							21	28
		A16							16	
		A22							21	
		A37							16	
		A45							21	
		A56							28	
		A70							21	
		A90							28	
		A100							16	
Double Pumps 		Outboard Pump	A16			A37	A56	28 ^{★2}	110	
		Inboard Pump	A16	A37	A56	A70	A220	A145		A90
Variable/Fixed Double Pumps 		Outboard Pump	PV2R1		PV2R2		28 ^{★2}	112		
		Inboard Pump	A16	A37	A56	A70	A220		A145	A90

★1 Various control types are available such as pressure compensator type. Refer to page 29 and 30.

★2 The maximum operating pressure for each double pump depends on its combination of pumps. Contact us for details.

Hydraulic Fluids

Hydraulic Fluids

Use petroleum based oils such as anti-wear type hydraulic oils equivalent to ISO VG-32 or 46. The recommended viscosity range is from 20 to 400 mm²/s and temperature range is from 0 to 60°C, both of which have to be satisfied for the use of the above hydraulic oils.

Control of Contamination

Due caution must be paid to maintaining control over contamination of the operating oil which can otherwise lead to breakdowns and shorten the life of the unit.

Please maintain the degree of contamination within NAS Grade 10.

The suction port must be equipped with at least a 100 μm (150 mesh) reservoir type filter and the return line must have a line type filter of under 10 μm.

Instructions

Mounting

When installing the pump the filling port should be positioned upwards.

Alignment of Shaft

Employ a flexible coupling whenever possible, and avoid any stress from bending or thrust.

Maximum permissible misalignment is less than 0.1 mm TIR and maximum permissible misangular is less than 0.2°.

Suction Pressure

Permissible suction pressure at inlet port of the pump is between -16.7 and +50 kPa.

For piping to the suction port, use the pipes of the same diameter as that of the specified pipe flange to be used. Make sure that the height of the pump suction port is within one metre from the oil level in the reservoir.

Hints on Piping

When using steel pipes for the suction or discharge ports, excessive load from the piping to the pump generates excessive noise.

Whenever there is fear of excessive load, please use rubber hoses.

Suction Piping

In case the pump is installed above the oil level, the suction piping and suction line filter should be located lower than the pump position to prevent air in the suction line.

When using steel pipes for the suction or discharge ports, excessive load from the piping to the pump generates excessive noise.

Whenever there is fear of excessive load, please use rubber hoses.

Drain Piping

Install drain piping according to the chart and ensure that pressure within the pump housing should be maintained at a normal pressure of less than 0.1 MPa and surge pressure of less than 0.5 MPa.

Length of piping should be less than 1 m, and the pipe end should be submerged in oil.

[Recommended Drain Piping Size]

Model	Fitting Size	Inside Dia. of Pipe
A10, A16, A22	3/8 [Inside Dia. 8.5 mm or more]	10 mm or more
A37, A45	1/2 [Inside Dia. 12 mm or more]	12 mm or more
A56, A70, A90, A100, A145	3/4 [Inside Dia. 16 mm or more]	19 mm or more

Bleeding Air

It may be necessary to bleed air from pump case and outlet line to remove causes of vibration. An air bleed valve (Model Number ST1004-*-10*, Page 265) is recommended for this purpose.

Starting

Before first starting, fill pump case with clean operating oil via the filling port.

In order to avoid air blockage when first starting, adjust the control valves so that the discharged oil from the pump is returned direct to the reservoir or the actuator moves in a free load.

[Volume of Pre-fill Oil Required]

Model	Volume cm ³
A10	370
A16/A22	600
A37/A45/A56	1200
A70	2100
A90/A100	2500
A145	3300

Setting Discharge Pressure and Delivery

At the time of shipment, the unit has been preset to maximum delivery and minimum discharge pressure.

Adjust the preset delivery and pressure to meet your system requirements.

Adjustment of Discharge Pressure

Turning the adjustment screw clockwise, increases pressure.

[Volume adjusted by each full turn of the pressure adjustment screw]

Model Numbers	Adjustment Volume MPa
A10-FR01B	2.9
A10-FR01C/H	5.4
A16/A22/A37/A56- *-R-01-B	3.5
A16/A22/A37/A56- *-R-01-C	6.5
A16/A37/A56- *-R-01-H	7.9
A70/A90/A100/A145- *-R01B	2.3
A70/A90/A100/A145- *-R01C	3.2
A70/A90/A100/A145- *-R01H	4.0
A70/A90/A100/A145- *-R01K	4.7

Adjustment of Delivery

Turning the flow adjustment screw clockwise, decreases delivery.

[The minimum adjustable flow and adjustable volume of each full turn of the delivery adjustment screw]

Model	Adjustable volume with each full turn of the adjustment screw cm ³ /rev	Minimum adjustment flow cm ³ /rev
A10	1.1	2.0
A16	1.4	4.0
A22	2.0	6.0
A37	2.9	10
A56	3.9	12
A70	4.4	36
A90	4.8	56
A100	5.2	62
A145	7.2	83

Series Variable Displacement Piston Pumps

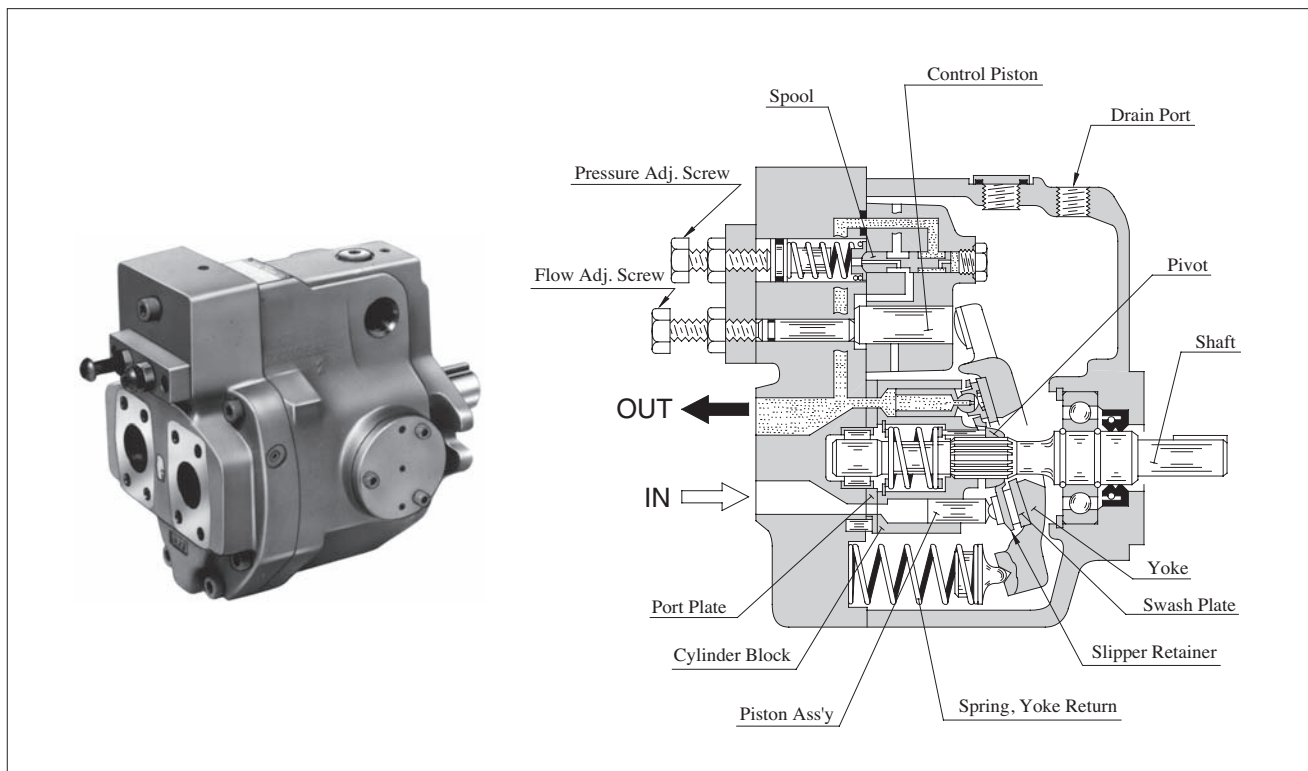

■ Features

● High efficiency

The efficiency properties in case of “A16” from are high efficiencies to be shown below.

● Low noise level

In the “A16” pump, the noise level is as low as 57.3 dB(A) [at the full cut-off pressure 21 MPa with speed 1500 r/min one metre horizontally away from pump head cover.]

“A16” type performance characteristics

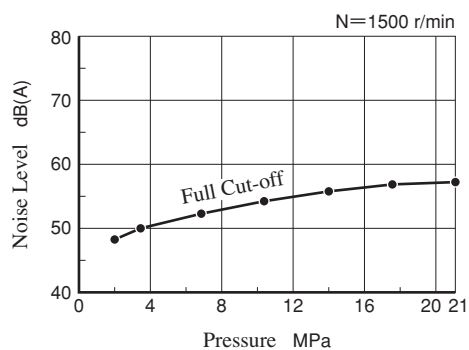
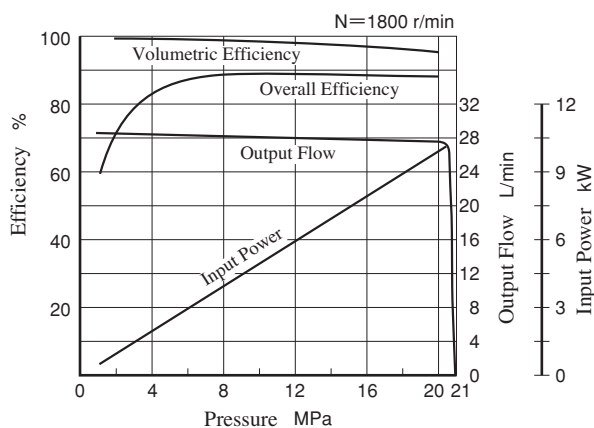

● Accomplishment of energy-saving

Because the overall efficiency is high and the cut-off characteristics is sharp, thus the input power may be saved.

● Low heat generation

Because of small power loss, it is possible to reduce the rise in oil temperature. Accordingly, capacity of a reservoir can be reduced.

Control Type

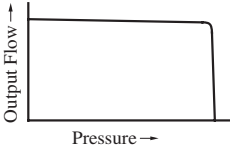
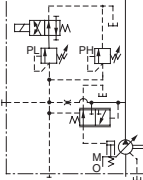
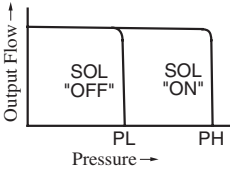
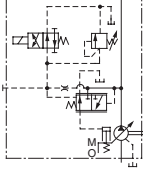
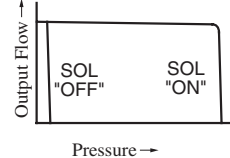
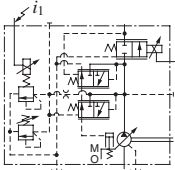
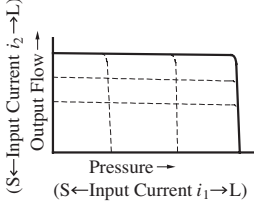
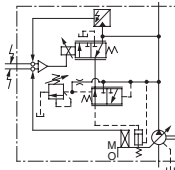
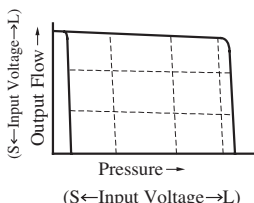
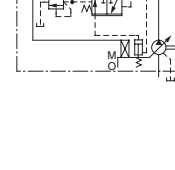
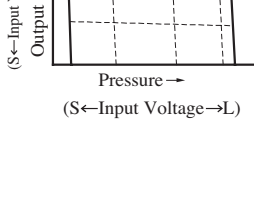
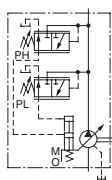
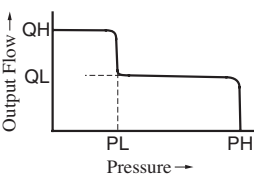
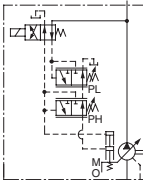
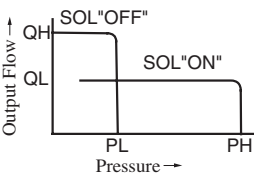
Control Type	Graphic Symbols	Performance Characteristics	Explanation	Page
"01" Pressure Compensator Type			When the system pressure increases and comes close to the preset cut-off pressure, the pump flow decreases automatically while maintaining the set pressure as it is.	31
"02" Solenoid-two Pressure Control Type			This type of control is ideal for an application where the output power of the actuator has to be controlled in two different load pressures while keeping the actuator speed nearly constant.	53
"03" Pressure Compensator with Unloading Type			It is suitable for a situation where a long unloading time is required and heat generation and noise have to be kept at their lowest levels. <ul style="list-style-type: none"> The pump can be used in combination with the multistage pressure control valve. 	61
"04" Proportional Electro-Hydraulic Load Sensing Type			This is an energy-saving type control which regulates the pump flow and load pressure to be at absolute minimum necessary level to operate the actuator. Pump flow rate and cut-off pressure are controlled proportional to the input current to the control device on the pump and the input current is regulated by the specific amplifier.	62
"04E" Electro-Hydraulic Proportional Pressure & Flow Control Type			This type of control has the pressure sensor and tilt angle sensor in the pump. The pump is used with the external amplifier (amplifier is integrated into pump in case of "04EH"). Flow and pressure can be controlled in proportion to input voltage by only one control valve.	72
"04EH" Electro-Hydraulic Proportional Pressure & Flow Control Type (OBE Type)			The features has been greatly improved by electrical feedback of swash plate tilt angle correspond to flow rate and load pressure to control valve. <ul style="list-style-type: none"> Linearity of input characteristics is excellent and easy to set. Hysteresis is lower, repeatability and reproducibility are fine. 	82
"05" Two-Pressure Two-Flow Control Type by System Pres.			This type of control is suitable for an application like "Presses" where the changeover from rapid advance to feed is required just when the pressing (pressurizing) starts.	91
"06" Two-Pressure Two-Flow Control Type by Solenoid Valve			This pump control is suitable for machining found on machine tool, where machining starts after the changeover from rapid advance, to feed has been made.	92

Control Type

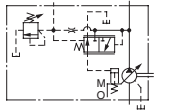
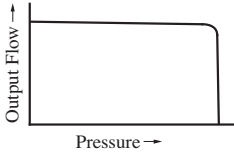
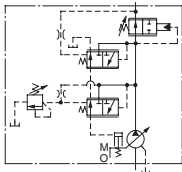
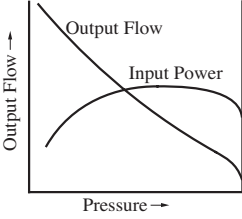
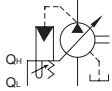
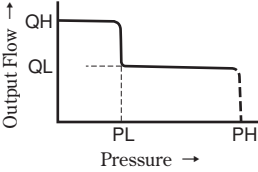
Control Type	Graphic Symbols	Performance Characteristics	Explanation	Page
"07" Pilot Pressure Control Type Pressure Compensator			The pump is used in combination with the pilot relief valve or multistage pressure control valve. By controlling the pilot pressure, the full cut-off pressure can be remote-controlled according to your requirements.	93
"09" Constant Power Control Type			<ul style="list-style-type: none"> • Pump input power can be controlled in accordance with the motor output. • When the discharge pressure rise, the output flow decreases corresponding to the preset input power. • The pump can act for function of two pumps, low-pressure large-flow and high-pressure small-flow. Therefore, the motor capacity can be reduced. 	101
"00-Z500" Simple Two-Pressure Two-Flow Control Type			<ul style="list-style-type: none"> • This type of control enables one pump to act as two pumps (low-pressure and large-flow/high-pressure and small-flow-rate). Therefore, the motor capacity can be reduced. • When the system pressure increases near the preset "PL" pressure due to the load increase, the pump flow automatically decreases to "QL." • This type of control is suitable for an application like the press, where switching from rapid advance to feed is required just when the press (pressurizing) starts. • The PH pressure can be remote-controlled with a separately located relief valve. With this type of control, it is easy to change the applied pressure setting when materials or shapes of the press are changed. 	109

Availability of Control Type

Mark "○" in the table below refers to standard model.

Model Numbers	Geometric Displacement cm ³ /rev	Control Type										
		01	02	03	04	04E	04EH	05	06	07	09	00-Z500
A10	10.0	○								○		
A16	15.8	○	○	○	○	○	○	○	○	○	○	○
A22	22.2	○	○	○	○	○	○		○	○		
A37	36.9	○	○	○	○	○	○	○	○	○	○	○
A45	45.0	○				○						
A56	56.2	○	○	○	○	○	○	○	○	○	○	○
A70	70.0	○	○	○	○	○	○		○	○	○	○
A90	91.0	○	○	○	○	○	○		○	○		○
A100	100	○			○	○						
A145	145	○	○	○	○	○	○		○	○	○	○
A220	219	○		○	○					○		

Series Variable Displacement Piston Pumps, Pressure Compensator Type

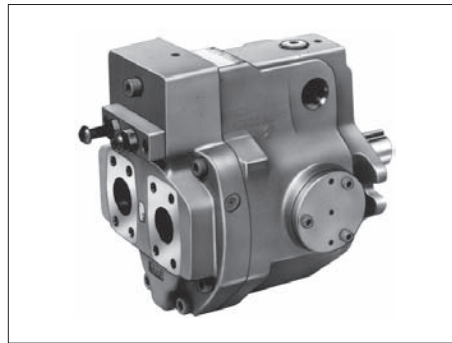

Graphic Symbol

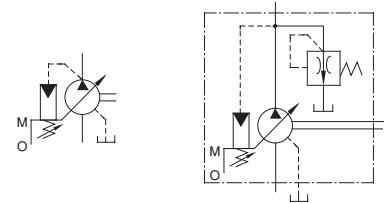

Applicable only for "A200"

Specifications

Model Numbers	Geometric Displacement cm ³ /rev	Minimum Adj. Flow cm ³ /rev	Operating Pressure MPa		Shaft Speed Range r/min		Approx. Mass kg	
			Rated ^{*2}	Intermittent ^{*1}	Max.	Min.	Flange Mtg.	Foot Mtg.
A10-FR01B-12	10.0	2	16	21	1800	600	5.1	—
A10-FR01C/H-12							8.5	
A16-*R-01-*-*K-32	15.8	4	16	21	1800	600	16.5	18.7
A22-*R-01-*-*K-32	22.2	6	16	16	1800	600	16.5	18.7
A37-*R-01-*-*K-32	36.9	10	16	21	1800	600	28.0	32.3
A56-*R-01-*-*K-32	56.2	12	16	21	1800	600	35.0	39.3
A70-*R01*S-60	70.0	36	25	28	1800	600	58.5	70.5
A90-*R01*S-60	91.0	56	25	28	1800	600	72.5	93
A100-*R01*S-10	100	62	21	21	1800	600	72.5	93
A145-*R01*S-60	145	83	25	28	1800	600	92.5	117.7

- ★1. Whenever setting pressure, make sure the full cut-off pressure never exceeds the maximum intermittent pressure.
- ★2. Care should be taken in cases of used at a higher pressure than the rated pressure, because operating terms may be restricted. For example, if used as per maximum illustrated operating conditions, intermittent time at maximum flow is restricted to under 1/5 of one cycle time and under six seconds simultaneously. Conditions may vary according to the actual working pressure and delivery (inclination angle of the swash plate). Consult factory or Yuken sales representative for further information.
- ★3. Care should be taken in cases of used at a higher pressure than the rated pressure, because operating terms may be restricted. For example, if used as per maximum illustrated operating conditions, intermittent time at maximum flow is restricted to under 1/5 of one cycle time and under six seconds simultaneously. Conditions may vary according to the actual working pressure and delivery (inclination angle of the swash plate). Consult factory or Yuken sales representative for further information.

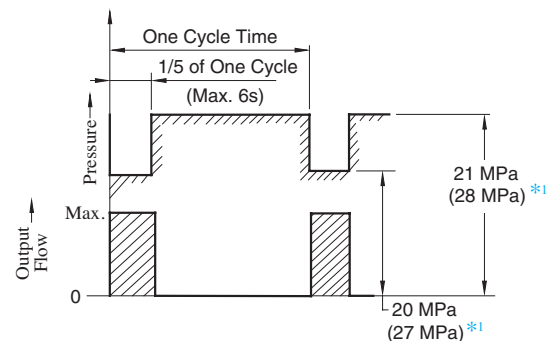

*1. Applicable only for "A70/90/145"

Specifications and Design numbers for Special Fluids

Type of Fluids	Pump Series	Operating Pressure MPa		Allowable Maximum Shaft Speed r/min		Temperature Range °C	Viscosity Range mm ² /s	Design Numbers for Special Fluid
		Rated	Intermittent	Rated	Max.			
Water-Glycols	A16-A56	14	16 (14) ^{★1}	1200	(1800) ^{★2}	0-50	20-200	3230
	A70-A145	21	21					6030
	A100	16	16					1030
Phosphate Ester Type	A16-A56	14	16 (14) ^{★1}	1200	(1800) ^{★2}	0-60	20-200	3206
	A70-A145	21	21					6006
	A100	21	21					1006
Polyol Ester Type	A16-A56	16	16	1800	1800	0-60	20-200	32450
	A70-A145	21	21					60450
	A100	21	21					10450

- ★1. The figures in brackets are for A22 type.
- ★2. As the specific gravities of water-glycol fluids and phosphate ester type fluids are higher than one, an overhead reservoir is required when pumps are operated at 1400 r/min or more.

Model Number Designation

A16	-F	-R	-01	-B	-S	-K	-32
Series Number	Mounting	Direction of Rotation	Control Type	Pres. Adj. Range MPa	Port Position	Shaft Extension	Design Number
A16 (15.8 cm ³ /rev)	F: Flange Mtg.	(Viewed from Shaft End)	01: Pressure Compensator Type	B: 1.2 - 7 C: 1.2 - 16 H: 1.2 - 21	None: Axial Port	K: Keyed Shaft	32
A22 (22.2 cm ³ /rev)				B: 1.2 - 7 C: 1.2 - 16			32
A37 (36.9 cm ³ /rev)	L: Foot Mtg.	R: Clockwise* ² (Normal)		B: 1.2 - 7 C: 1.2 - 16 H: 1.2 - 21	S: Side Port		32
A56 (56.2 cm ³ /rev)							32

A70	-F	R	01	B	S	-60	
Series Number	Mounting	Direction of Rotation	Control Type	Pres. Adj. Range MPa	Port Position	Design Number	
A10 (10.0 cm ³ /rev)	F: Flange* ¹ Mtg.	(Viewed from Shaft End)	01: Pressure Compensator Type	B: 1.2 - 7 C: 2.0 - 16 H: 2.0 - 21	—	12	
A70 (70.0 cm ³ /rev)	F: Flange Mtg. L: Foot Mtg.			R: Clockwise* ² (Normal)	B: 1.2 - 7 C: 1.5 - 16 H: 1.8 - 21 K: 2.0 - 28	S: Side Port	60
A90 (91.0 cm ³ /rev)							60
A100 (100 cm ³ /rev)							60
A145 (145 cm ³ /rev)							60

★ 1. When A10 pump is used as the foot Mtg., order the Mtg. Bracket kit shown below separately. Refer to page 20 for dimensions of the Mtg. bracket.

Note: The mounting bracket kit consists of a mounting bracket, two hex. bolts and two plain washer.

Mtg. Bracket Kit Numbers	Approx. Mass kg
LP-1A-10	2.2

★ 2. Available to supply pump with anti-clockwise rotation (Except A100). Consult Yuken for details.

Pipe Flange Kits

Pipe flange kits are available. When ordering, specify the kit number from the table below.

Pump Model Numbers	Name of Port	Pipe Flange Kit Numbers		
		Threaded Connection	Socket Welding* ¹	Butt Welding
A16-*R01	Suction	F5-06-A-10	F5-06-B-10	F5-06-C-10
A22-*R01	Discharge	F5-06-A-10	F5-06-B-10	F5-06-C-10
A37-*R01	Suction	F5-10-A-10	F5-10-B-10	F5-10-C-10
A56-*R01	Discharge	F5-10-A-10	F5-10-B-10	F5-10-C-10
A70-*R01	Suction	F5-12-A-10	F5-12-B-10	F5-12-C-10
	Discharge	F5-08-A-10	F5-08-B-10	F5-08-C-10
A90-*R01	Suction	F5-16-A-10	F5-16-B-10	F5-16-C-10
A100-*R01	Discharge	F5-10-A-10	F5-10-B-10	F5-10-C-10
A145-*R01				

★ In case of using socket welding flanges, there is a case where the operating pressure should be set lower than the normal because of strength of the flanges. Therefore, please pay cautious attention to the operating pressure when the socket welding flanges are used.

● Details of the pipe flange kits are shown on page 262.

The below pumps are also available.
Please consult Yuken.

Model Number		A45-*.R-01-*.K-10	A220-*.R-01-*.K-10
Maximum Operating Pressure	MPa	16	16
Geometric Displacement	cm ³ /rev	45.0	219
Shaft Speed Range	r/min	600 - 1800	600 - 1500

Response Characteristics Change in Accordance with Circuits and Operating Conditions.

The Circuit and Conditions

Circuit

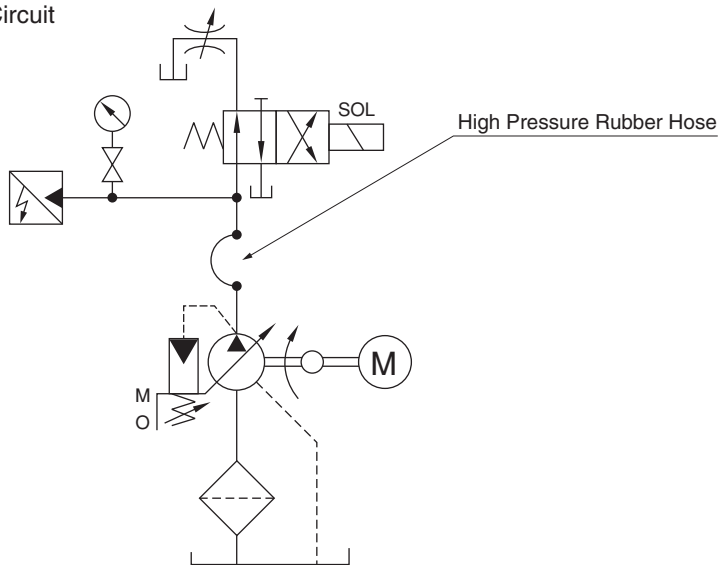

Model	Rubber Hose Size
A10	1/2"× 800 mm
A16 A22	3/4"× 700 mm
A37 A56	3/4"× 2000 mm
A70	3/4"× 3500 mm
A90 A100 A145	3/4"× 3000 mm + 1-1/4" × 2000 mm

Conditions

Shaft Speed : 1500 r/min
Hydraulic Fluid : ISO VG 32 Oil
Oil Temperature: See right table

Model	Oil Temperature
A10 - A56	50°C (20 mm ² /s)
A70 - A145	40°C (32 mm ² /s)

Result of Measurement

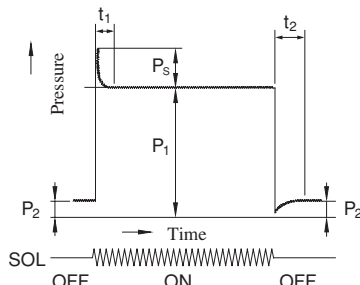

Model	Full Cut-off Pressure P ₁ MPa	Pressure at Full Flow P ₂ MPa	Response Time ms		Overshoot Pressure P _s MPa
			t ₁	t ₂	
A10	21	2	100	75	2.6
A16	16	2	38*	59*	3.6
A22	16	2	30*	72*	5.9
A37	16	2	40*	78*	7.8
A56	16	2	38*	88*	7.6
A70	25	2	80	100	7.8
A90	25	3	90	110	7.9
A100	21	3	90	110	8.1
A145	25	3	100	150	8.8

* Response time except A16, A22, A37 and A56 is measured Yoke travel.

Typical Performance Characteristics of Type **A10** at Viscosity 20 mm²/s [ISO VG32 Oils, 50°C]

Performance Characteristic Curve

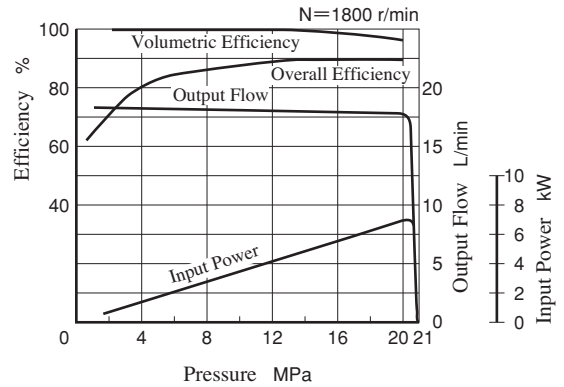
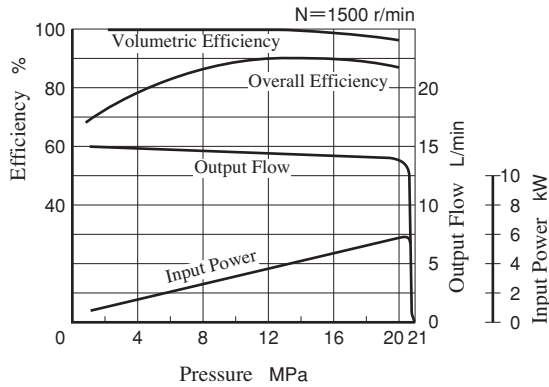

Input Power

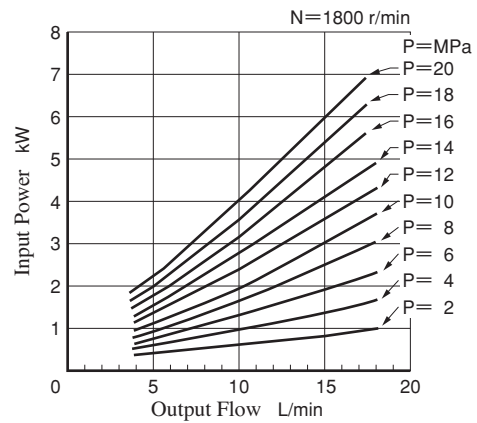
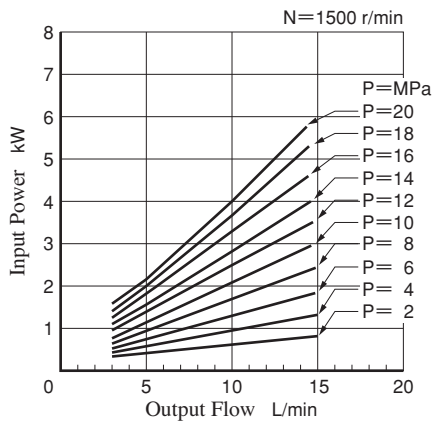

Full Cut-off Power

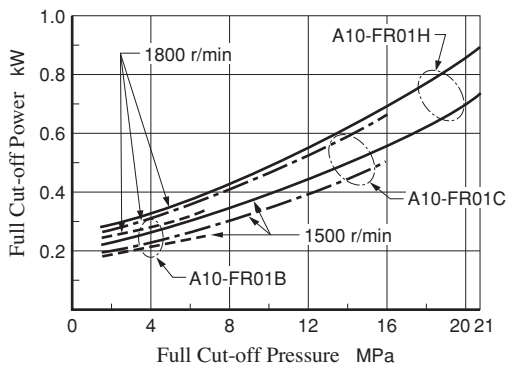

Drain

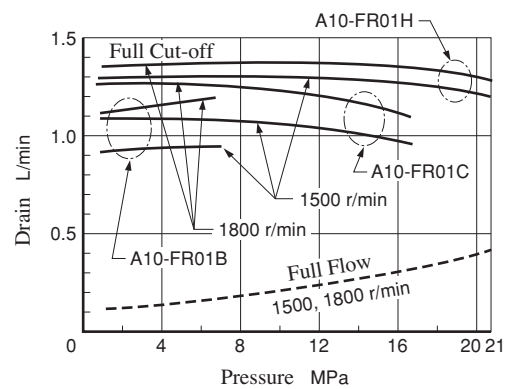

Noise Level [One metre horizontally away from pump head cover]

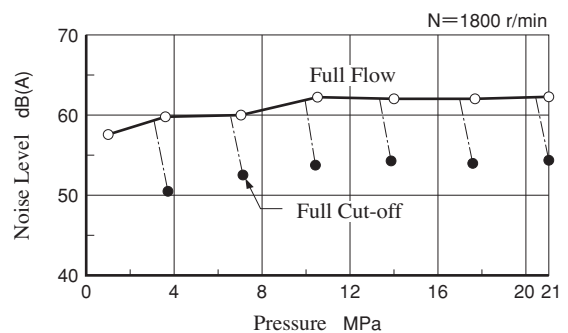
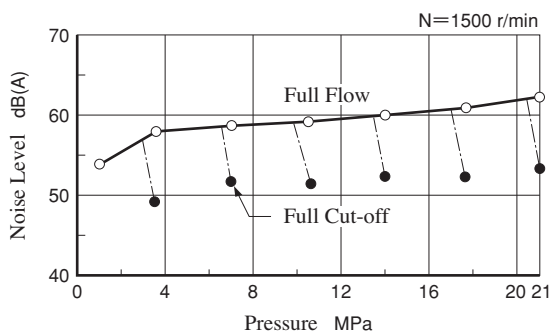

Typical Performance Characteristics of Type A16 at Viscosity 20 mm²/s [ISO VG32 Oils, 50°C]

Performance Characteristic Curve

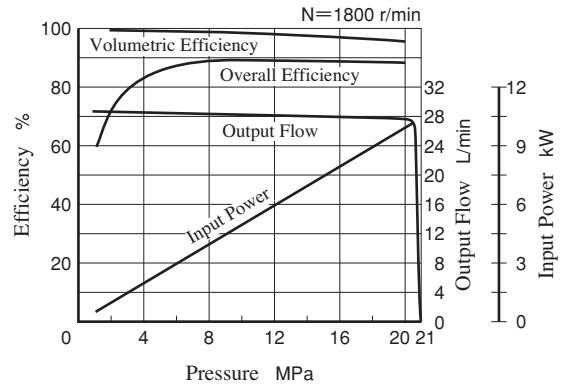
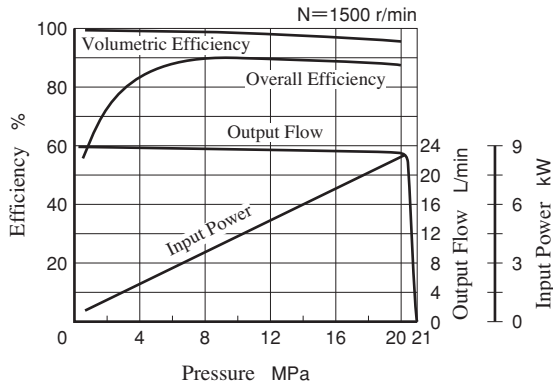

Input Power

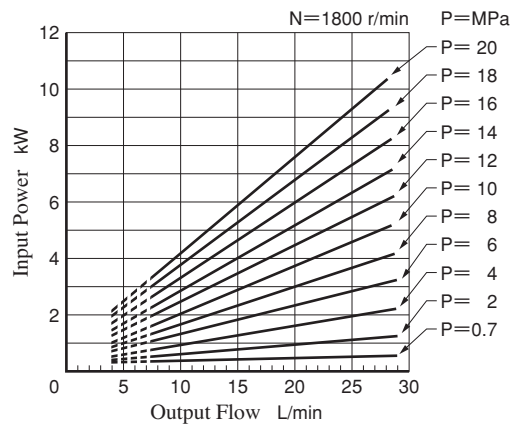
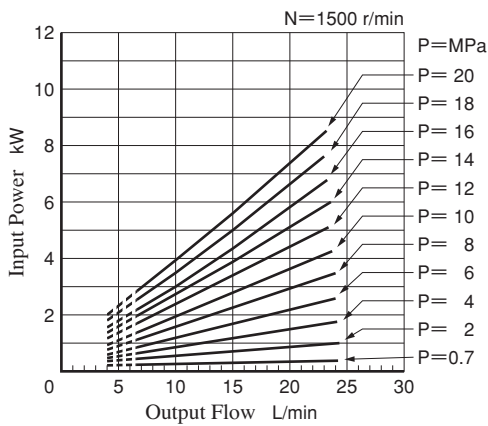

Full Cut-off Power

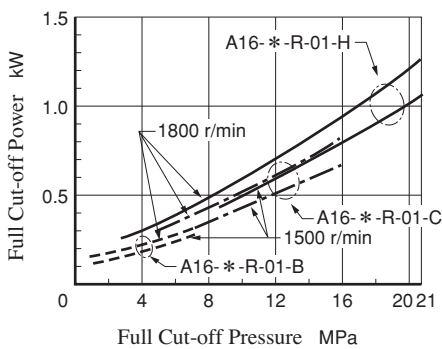

Drain

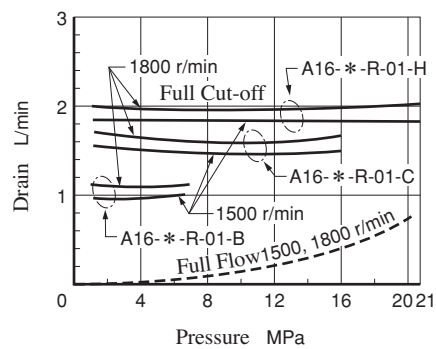

Noise Level [One metre horizontally away from pump head cover]

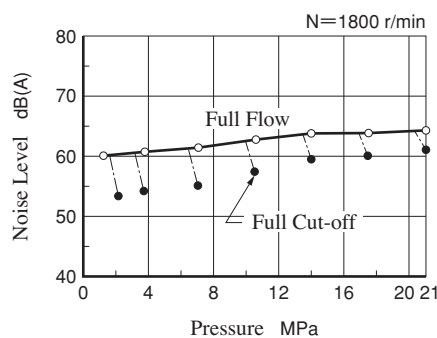
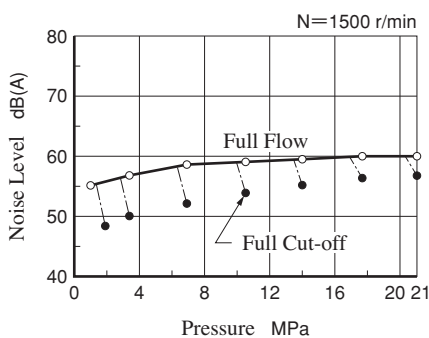

Typical Performance Characteristics of Type **A22** at Viscosity 20 mm²/s [ISO VG32 Oils, 50°C]

Performance Characteristic Curve

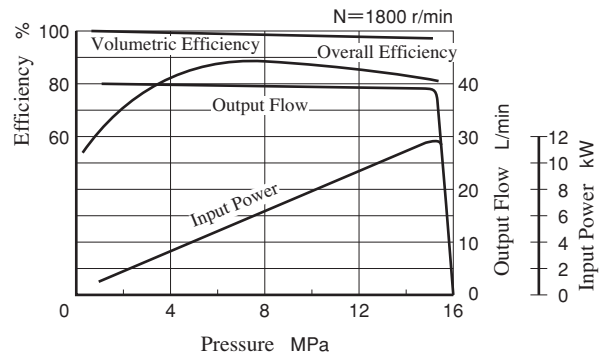
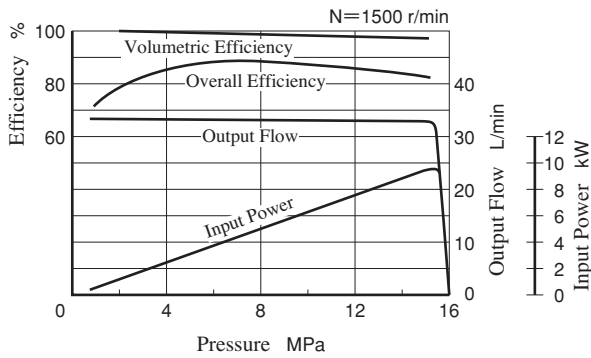

Input Power

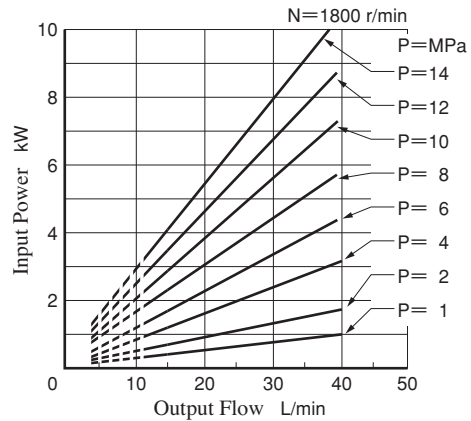
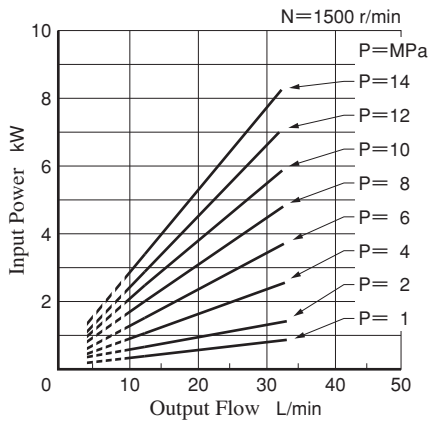

Full Cut-off Power

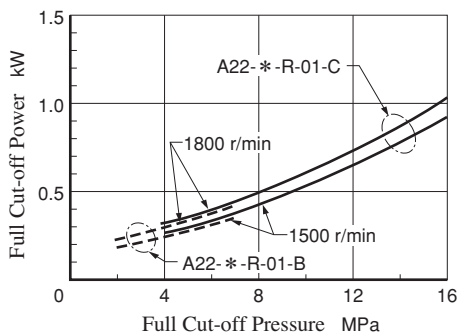

Drain

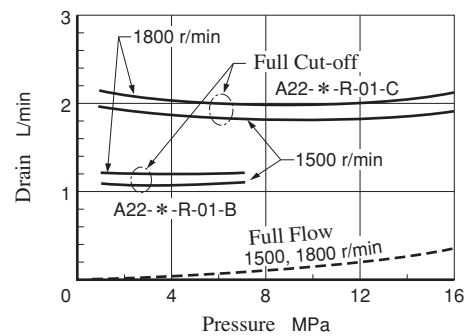

Noise Level [One metre horizontally away from pump head cover]

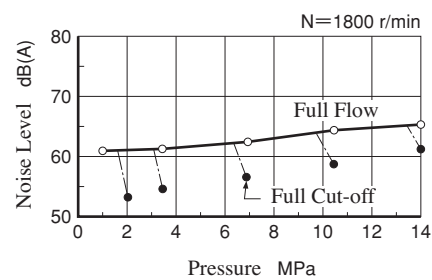
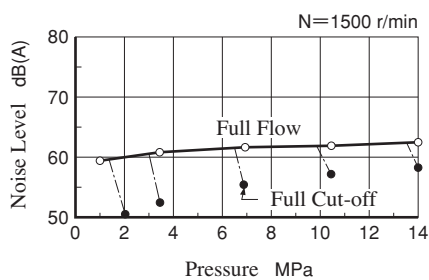

Typical Performance Characteristics of Type **A37** at Viscosity 20 mm²/s [ISO VG32 Oils, 50°C]

Performance Characteristic Curve

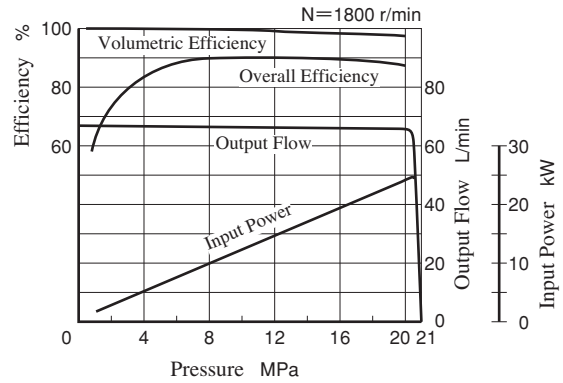
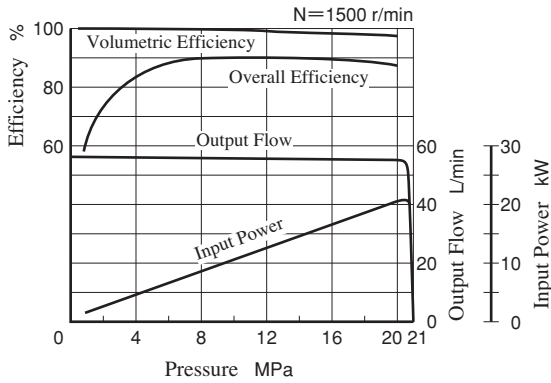

Input Power

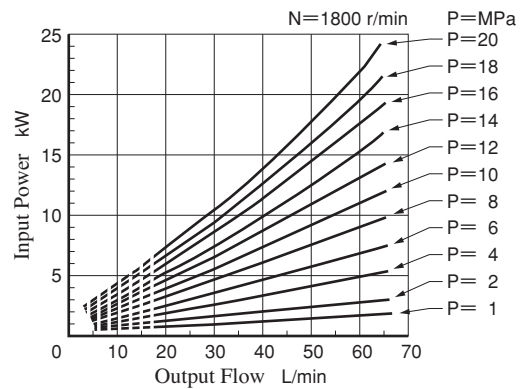
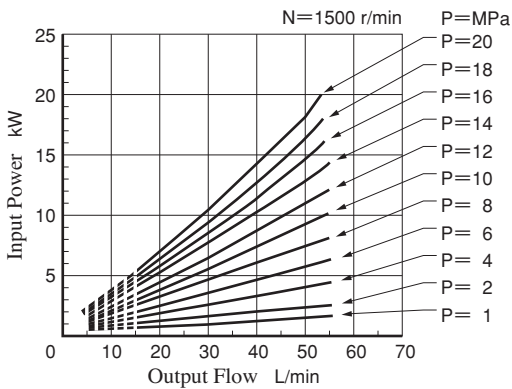

Full Cut-off Power

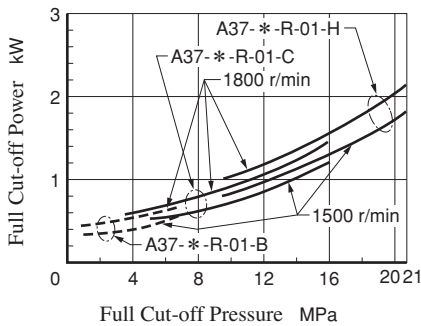

Drain

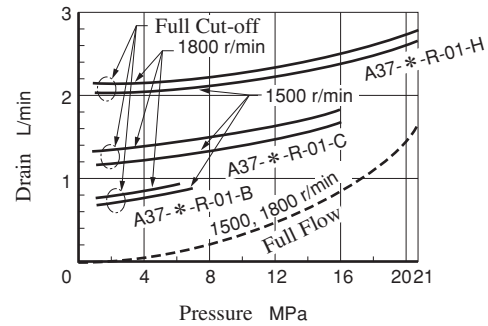

Noise Level [One metre horizontally away from pump head cover]

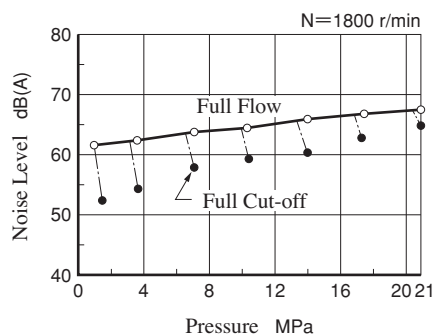
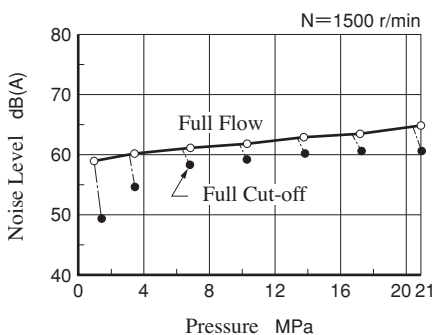

Typical Performance Characteristics of Type **A56** at Viscosity 20 mm²/s [ISO VG32 Oils, 50°C]

Performance Characteristic Curve

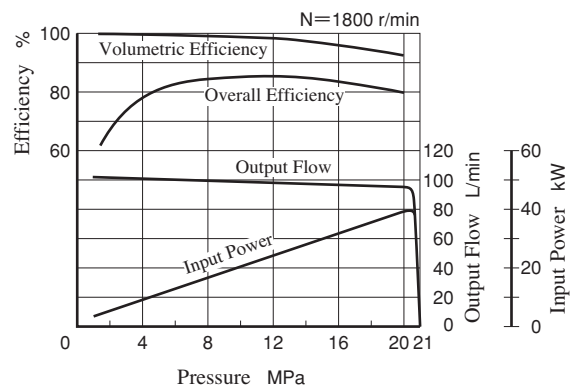
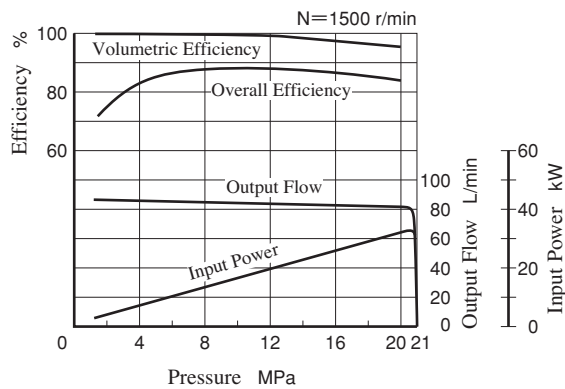

Input Power

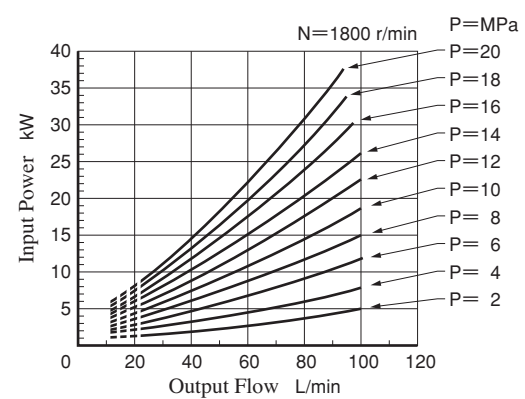
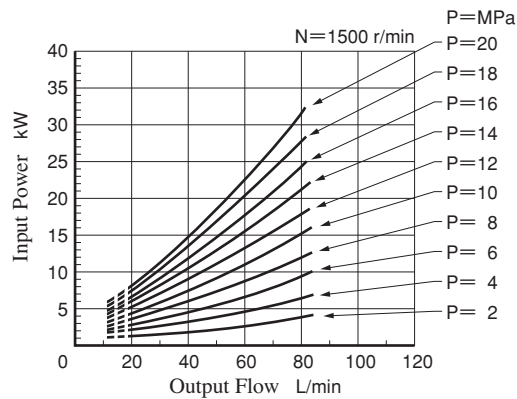

Full Cut-off Power

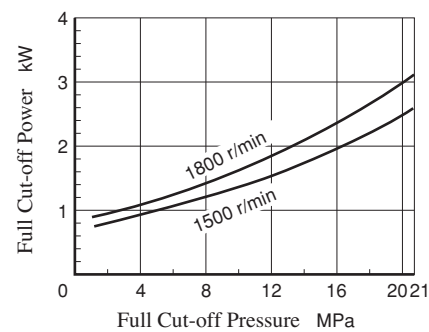

Drain

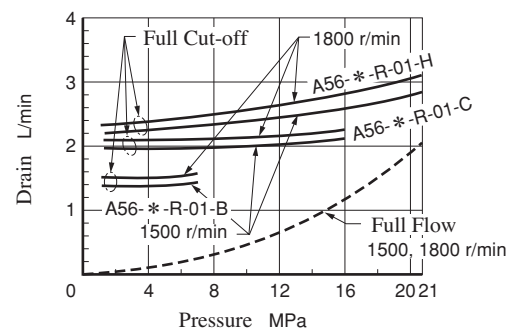

Noise Level [One metre horizontally away from pump head cover]

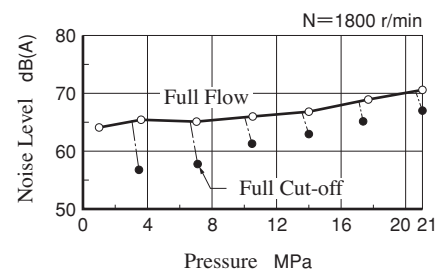
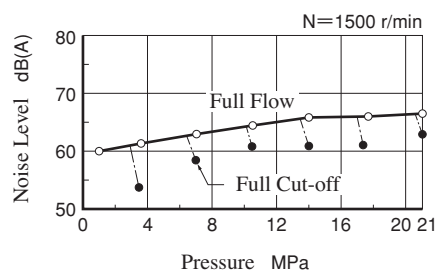

Typical Performance Characteristics of Type **A70** at Viscosity 20 mm²/s [ISO VG32 Oils, 50°C]

Performance Characteristic Curve

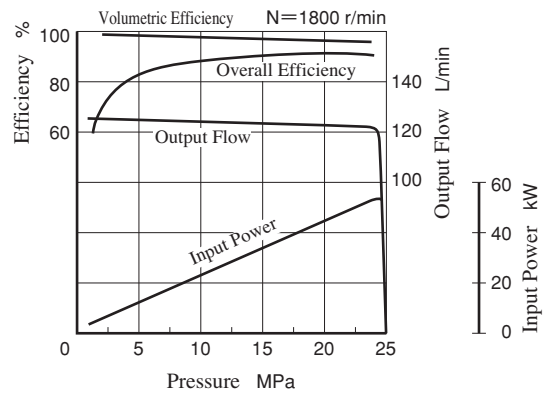
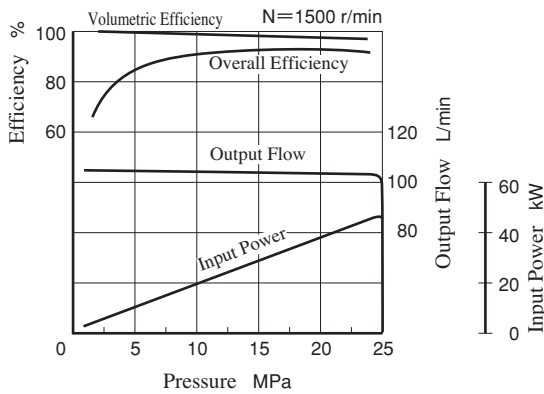

Input Power

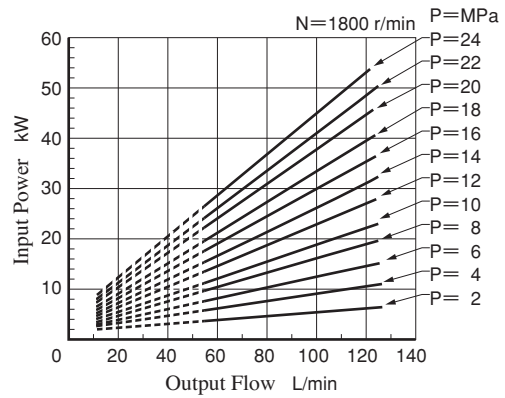
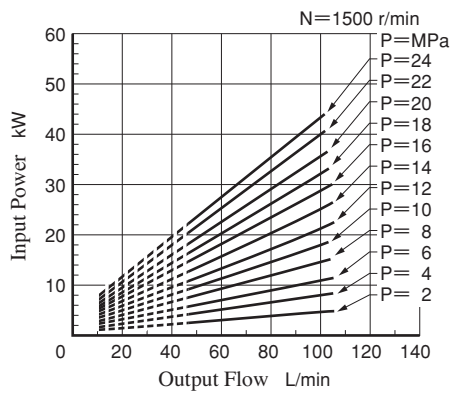

Full Cut-off Power

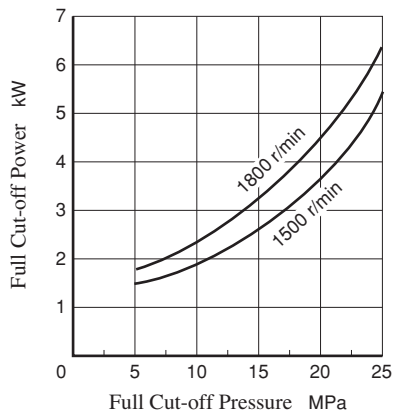

Drain

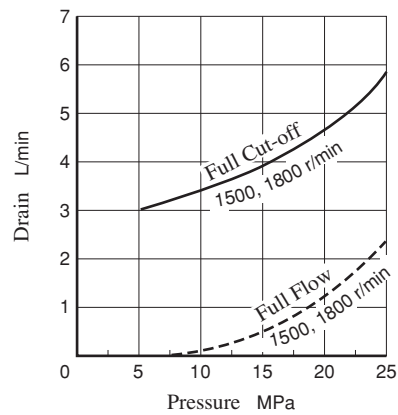

Noise Level [One metre horizontally away from pump head cover]

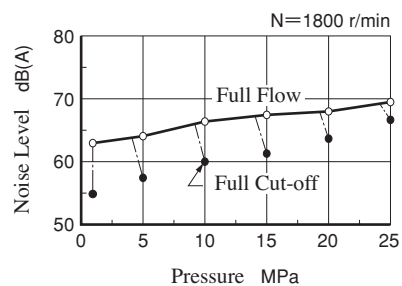
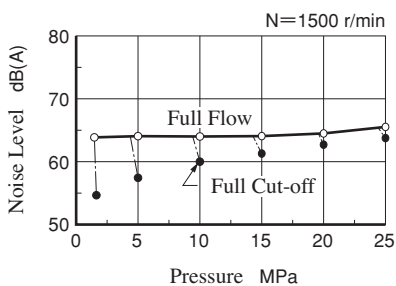

Typical Performance Characteristics of Type **A90** at Viscosity 20 mm²/s [ISO VG32 Oils, 50°C]

Performance Characteristic Curve

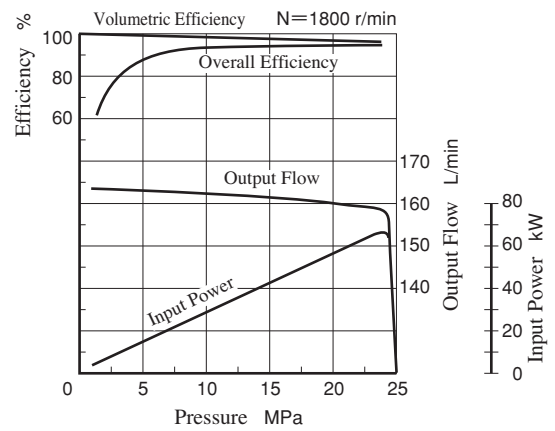
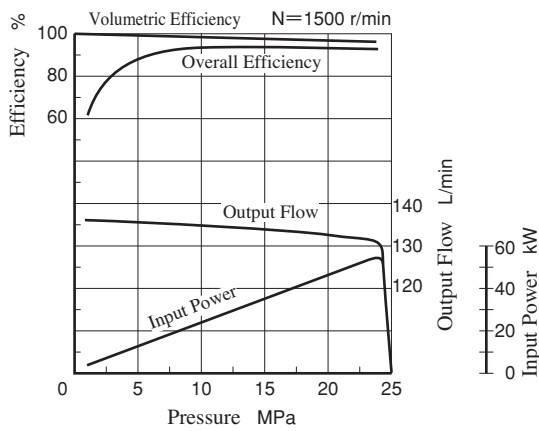

Input Power

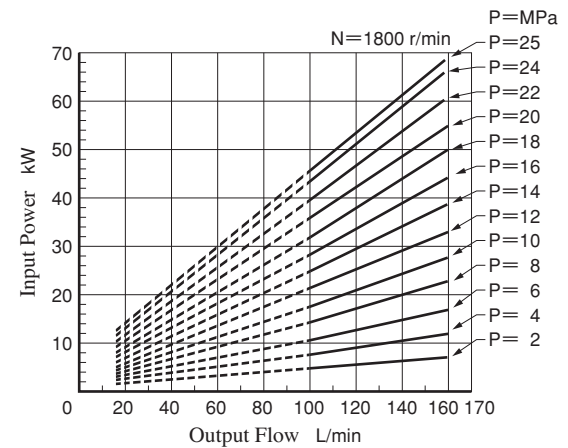
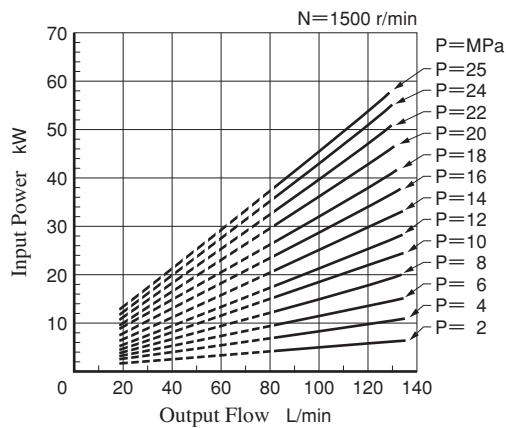

Full Cut-off Power

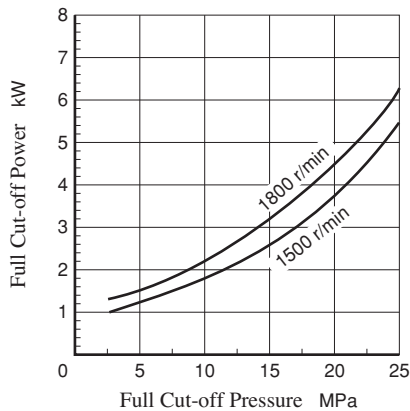

Drain

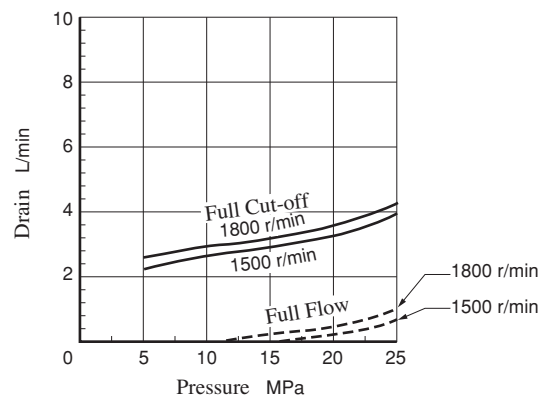

Noise Level [One metre horizontally away from pump head cover]

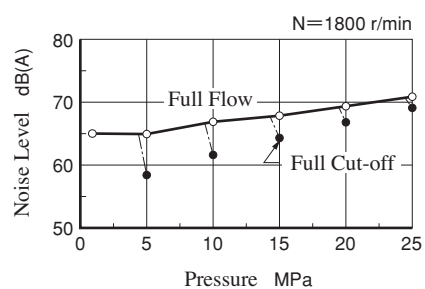
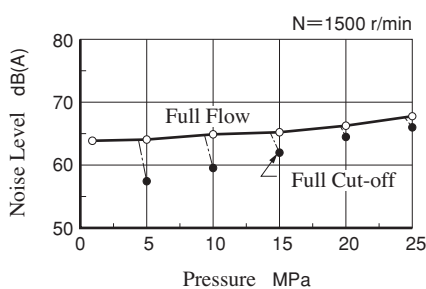

Typical Performance Characteristics of Type A100 at Viscosity 20 mm²/s [ISO VG32 Oils, 50°C]

Performance Characteristic Curve

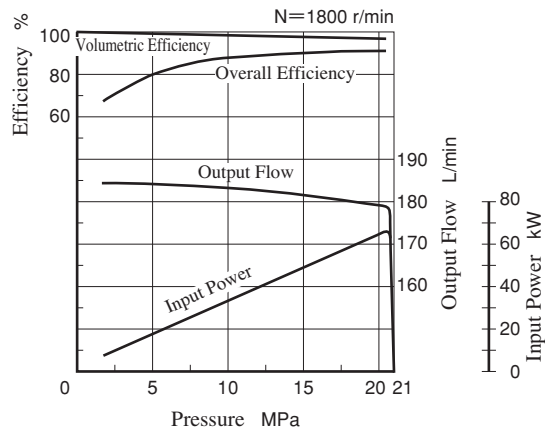
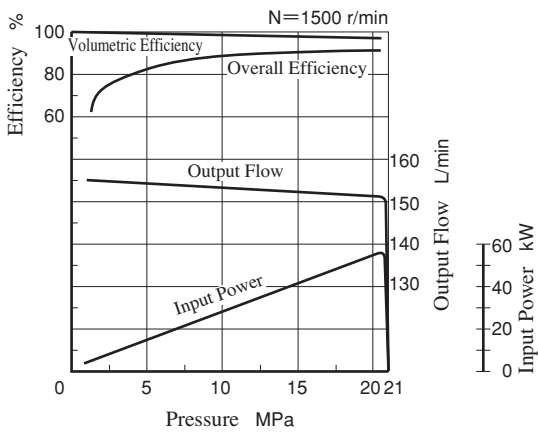

Input Power

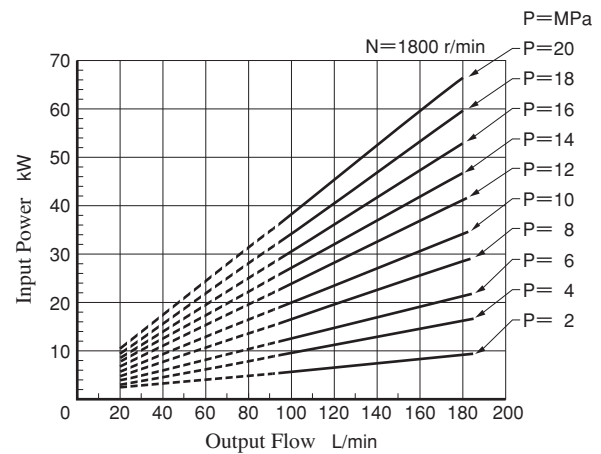
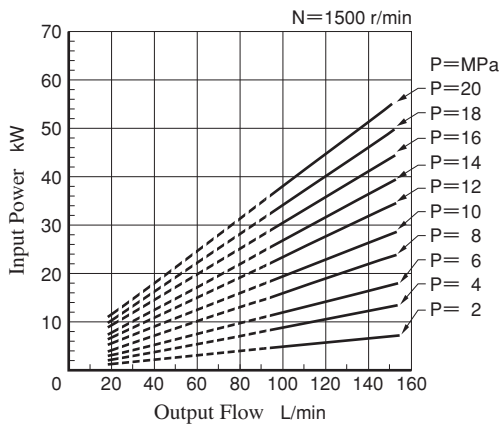

Full Cut-off Power

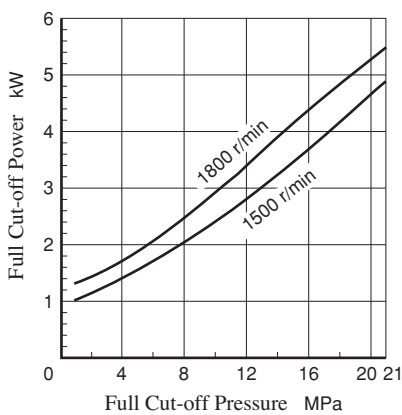

Drain

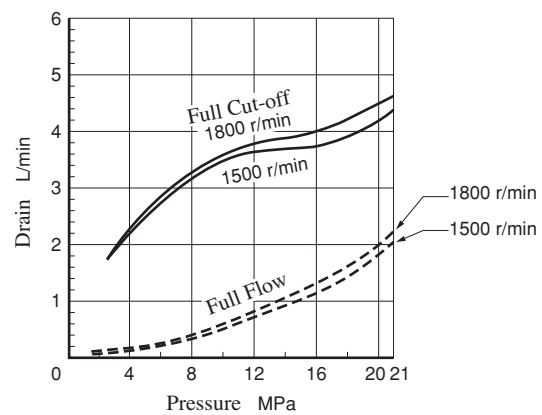

Noise Level [One metre horizontally away from pump head cover]

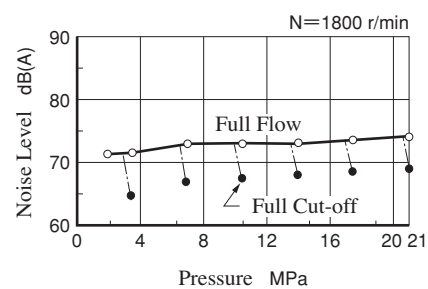
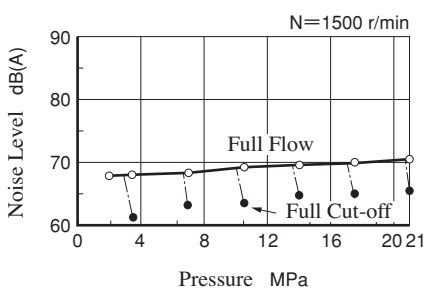

Typical Performance Characteristics of Type **A145** at Viscosity 20 mm²/s [ISO VG32 Oils, 50°C]

Performance Characteristic Curve

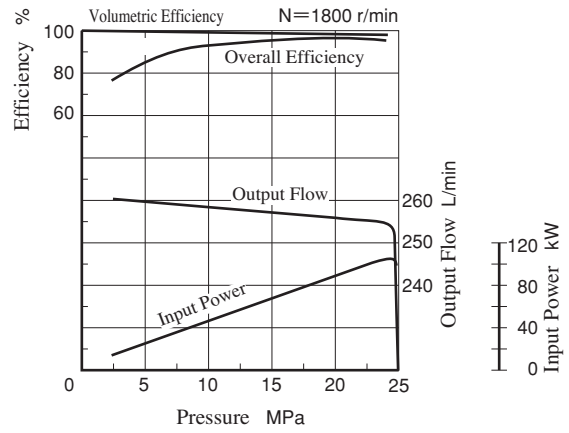
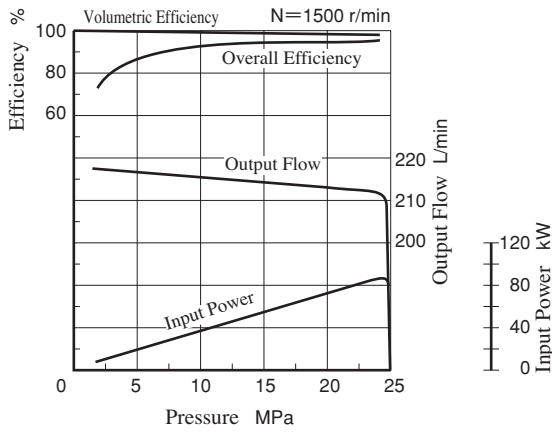

Input Power

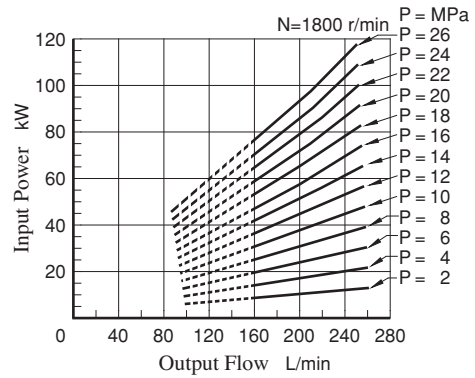
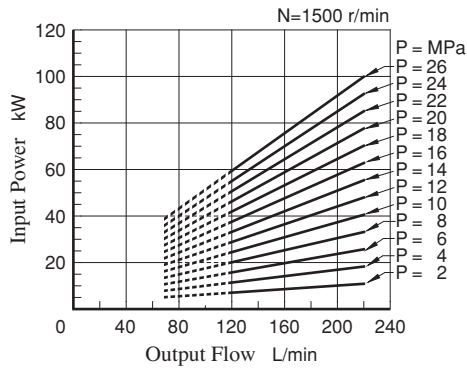

Full Cut-off Power

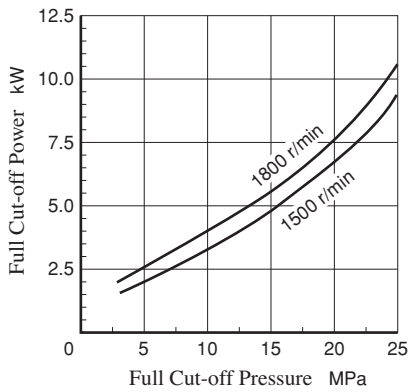

Drain

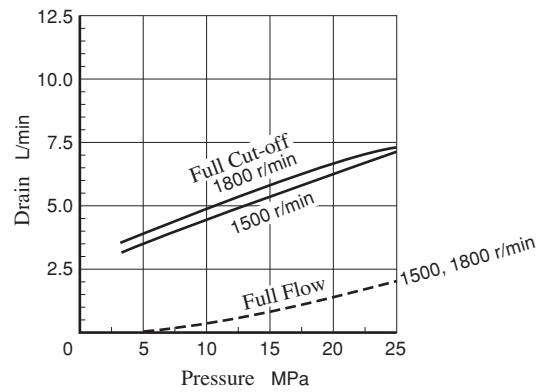

Noise Level [One metre horizontally away from pump head cover]

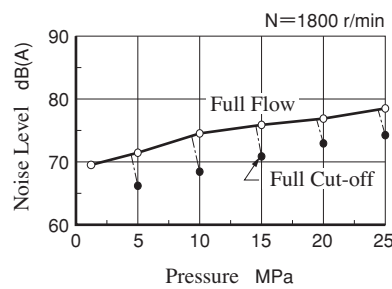
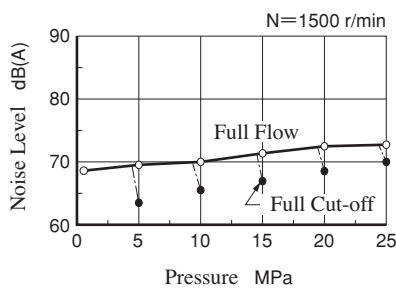

Flange Mtg. : A10-FR01 *

DIMENSIONS IN MILLIMETRES

● A10-FR01C/H

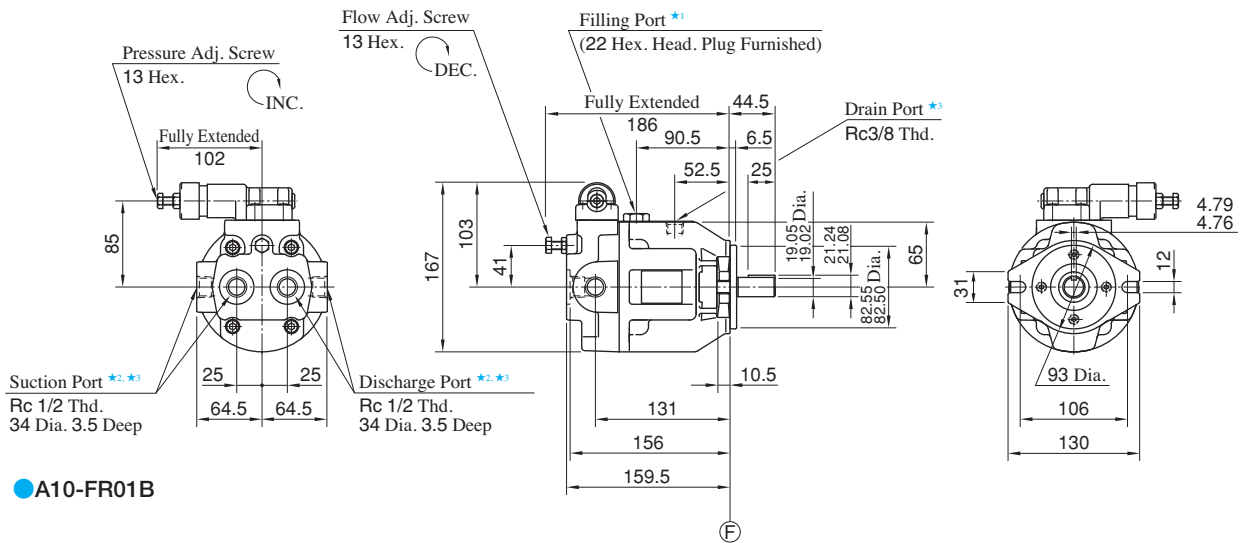

● A10-FR01B

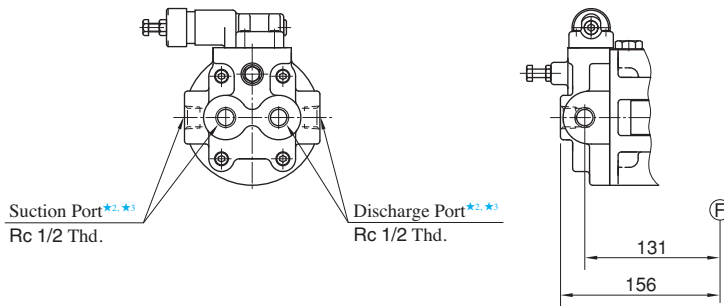

- ★1. Install the pump so that the "Filling Port" is at the top.
- ★2. Use either port of two suction and discharge ports at your option. Keep the remaining ports plugged.
- ★3. As the tightening torques of suction, discharge and drain port fittings, conform to the below.

Name of Port	Tightening Torque Nm
Suction	65 - 75
Discharge	
Drain	40 - 50

Axial Port Type

DIMENSIONS IN MILLIMETRES

**Flange Mtg. : A16-F-R-01- *-K
A22-F-R-01- *-K**

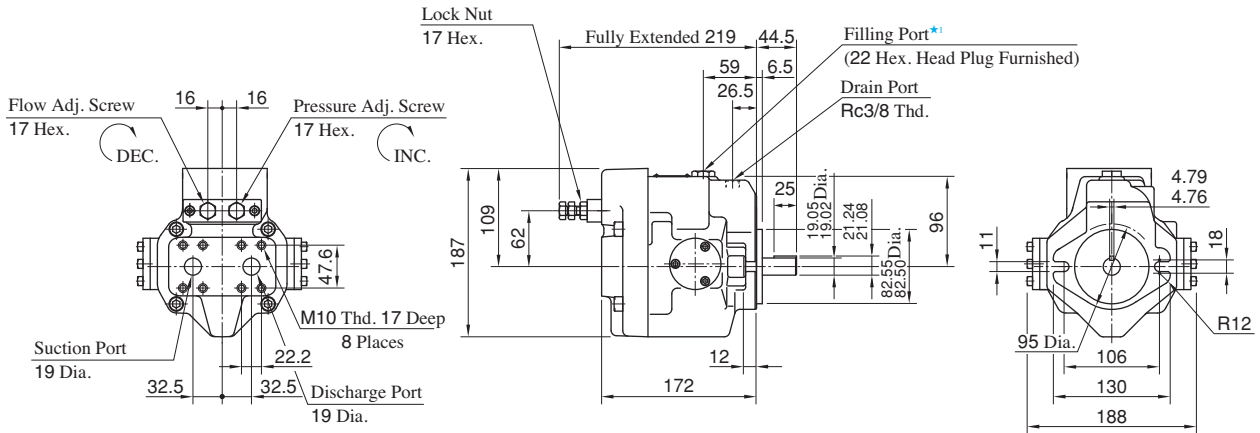

★ 1. Install the pump so that the “Filling Port” is at the top.

**Foot Mtg. : A16-L-R-01- *-K
A22-L-R-01- *-K**

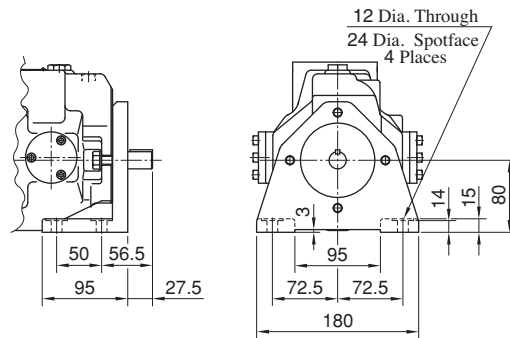

● For other dimensions, refer to “Flange Mtg.”.

Side Port Type

DIMENSIONS IN MILLIMETRES

**Flange Mtg. : A16-F-R-01- *-S-K
A22-F-R-01- *-S-K**

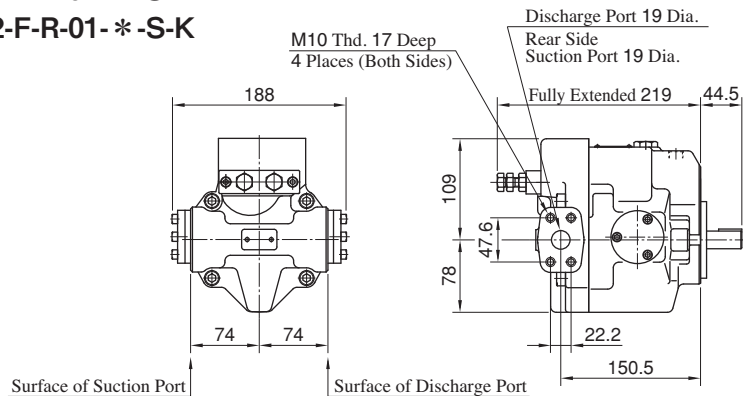

● For other dimensions, refer to “Axial Port Type”.
● Foot Mtg. Type : Mounting bracket is common to that of “Axial Port Type”.

Axial Port Type

Flange Mtg. : A37-F-R-01- *-K

DIMENSIONS IN MILLIMETRES

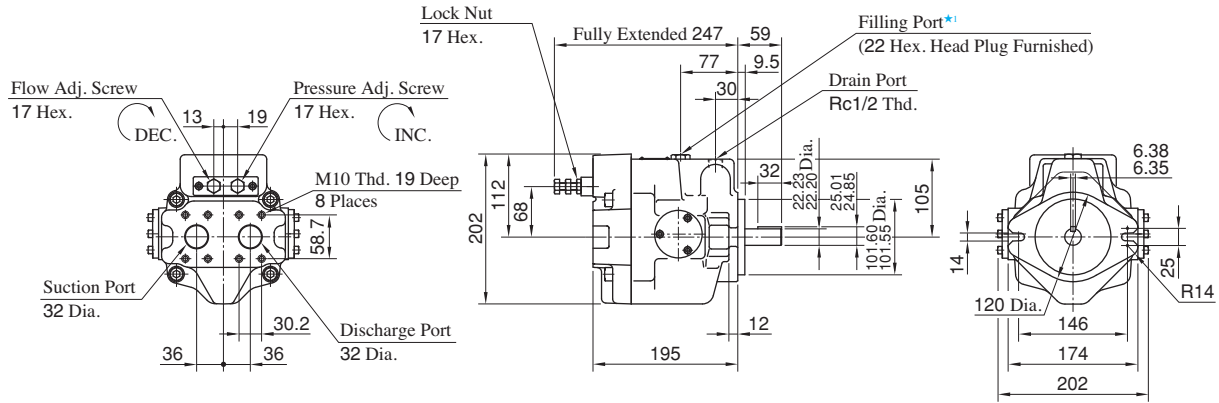

★ 1. Install the pump so that the "Filling Port" is at the top.

Foot Mtg. : A37-L-R-01- *-K

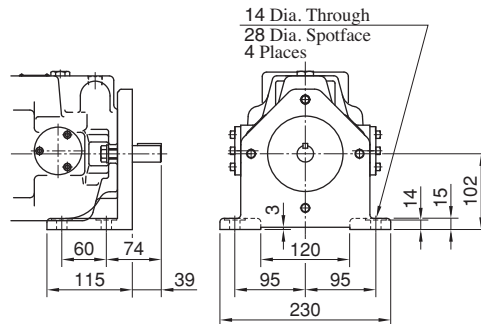

● For other dimensions, refer to "Flange Mtg."

Side Port Type

Flange Mtg. : A37-F-R-01- *-S-K

DIMENSIONS IN MILLIMETRES

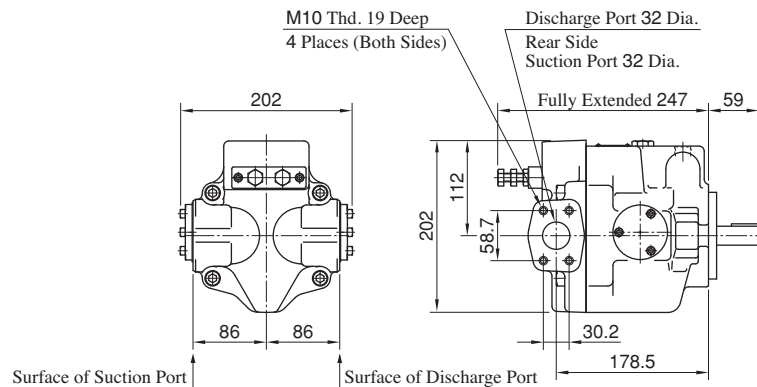

● For other dimensions, refer to "Axial Port Type".

● Foot Mtg. Type : Mounting bracket is common to that of "Axial Port Type".

Axial Port Type

Flange Mtg. : A56-F-R-01- *-K

DIMENSIONS IN MILLIMETRES

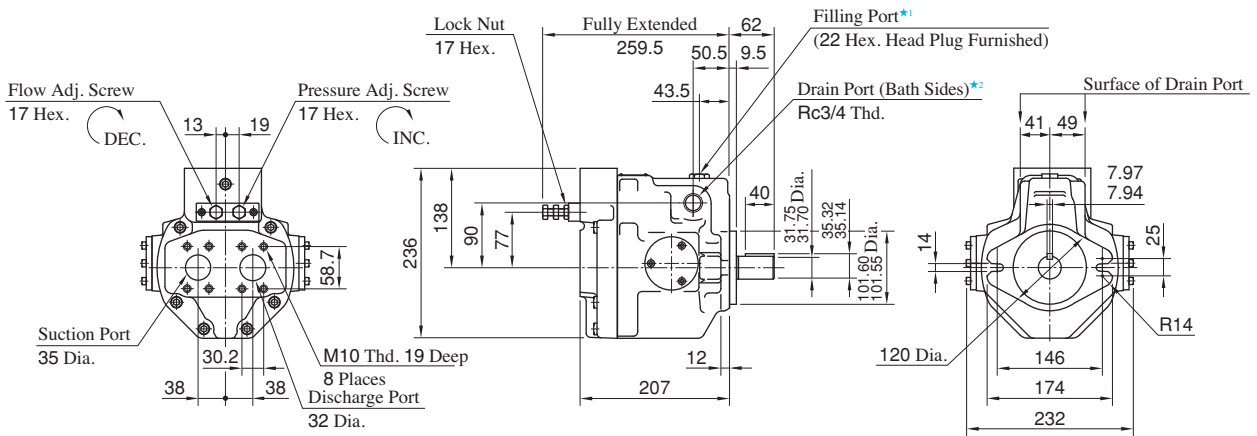

- ★ 1. Install the pump so that the “Filling Port” is at the top.
- ★ 2. Use either port of the two drain ports at your option. Keep the remaining port plugged.

Foot Mtg. : A56-L-R-01- *-K

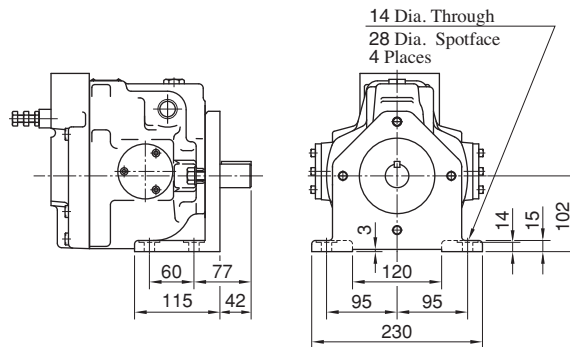

● For other dimensions, refer to “Flange Mtg.”.

Side Port Type

Flange Mtg. : A56-F-R-01- *-S-K

DIMENSIONS IN MILLIMETRES

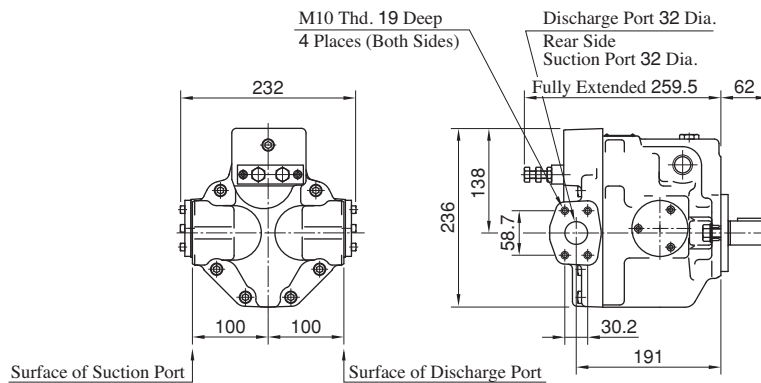

● For other dimensions, refer to “Axial Port Type”.

Side Port Type

Flange Mtg. : A70-FR01 * S

DIMENSIONS IN MILLIMETRES

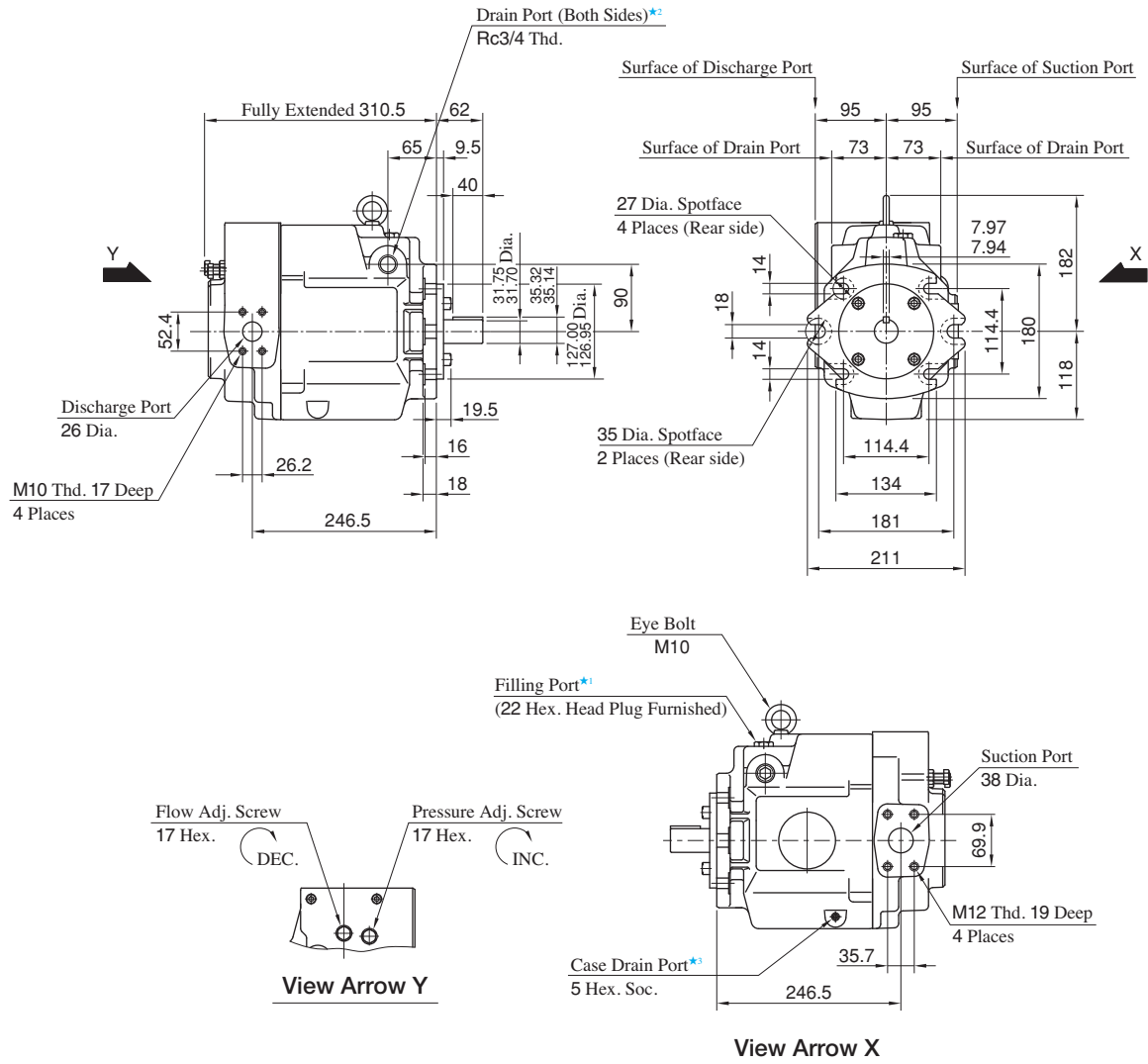

- ★1. Install the pump that the "Filling Port" is at the top.
- ★2. Use either port of the two drain port at your option. Keep the remaining port plugged.
- ★3. Case drain port is available for use when draining hydraulic fluid from pump casing.

Foot Mtg. : A70-LR01 * S

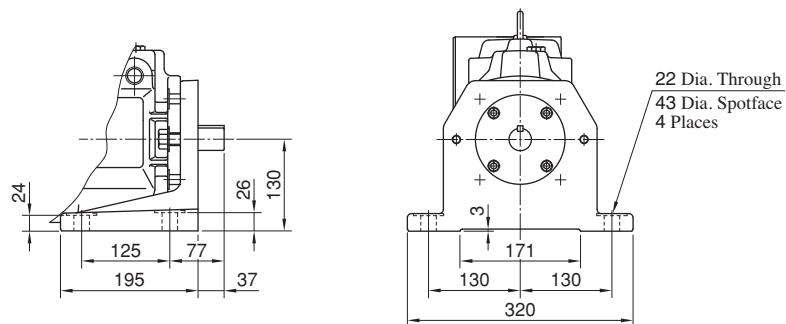

● For other dimensions, refer to "Flange Mtg."

Side Port Type

DIMENSIONS IN MILLIMETRES

**Flange Mtg. : A90-FR01 * S
A100-FR01 * S**

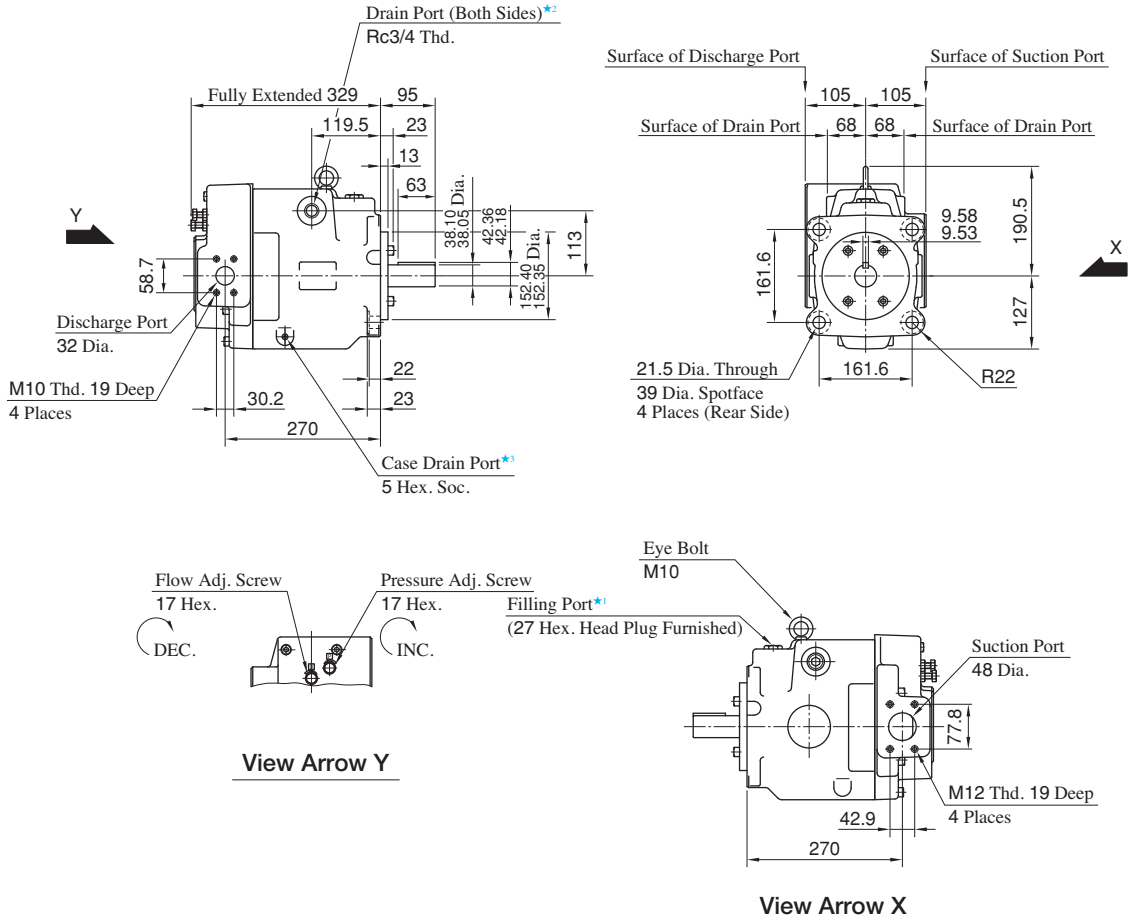

- ★1. Install the pump that the “Filling Port” is at the top.
- ★2. Use either port of the two drain port at your option. Keep the remaining port plugged.
- ★3. Case drain port is available for use when draining hydraulic fluid from pump casing.

**Foot Mtg. : A90-LR01 * S
A100-LR01 * S**

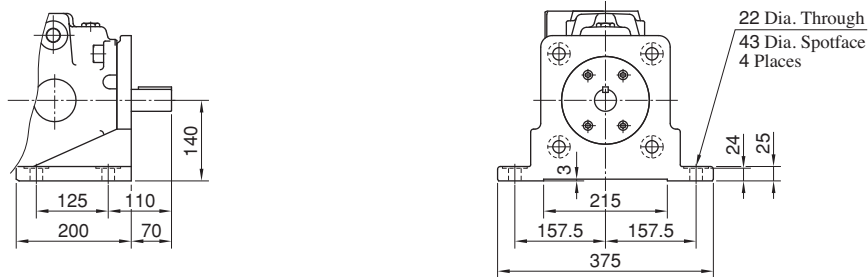

● For other dimensions, refer to “Flange Mtg.”.

Side Port Type

DIMENSIONS IN MILLIMETRES

Flange Mtg. : A145-FR01 * S

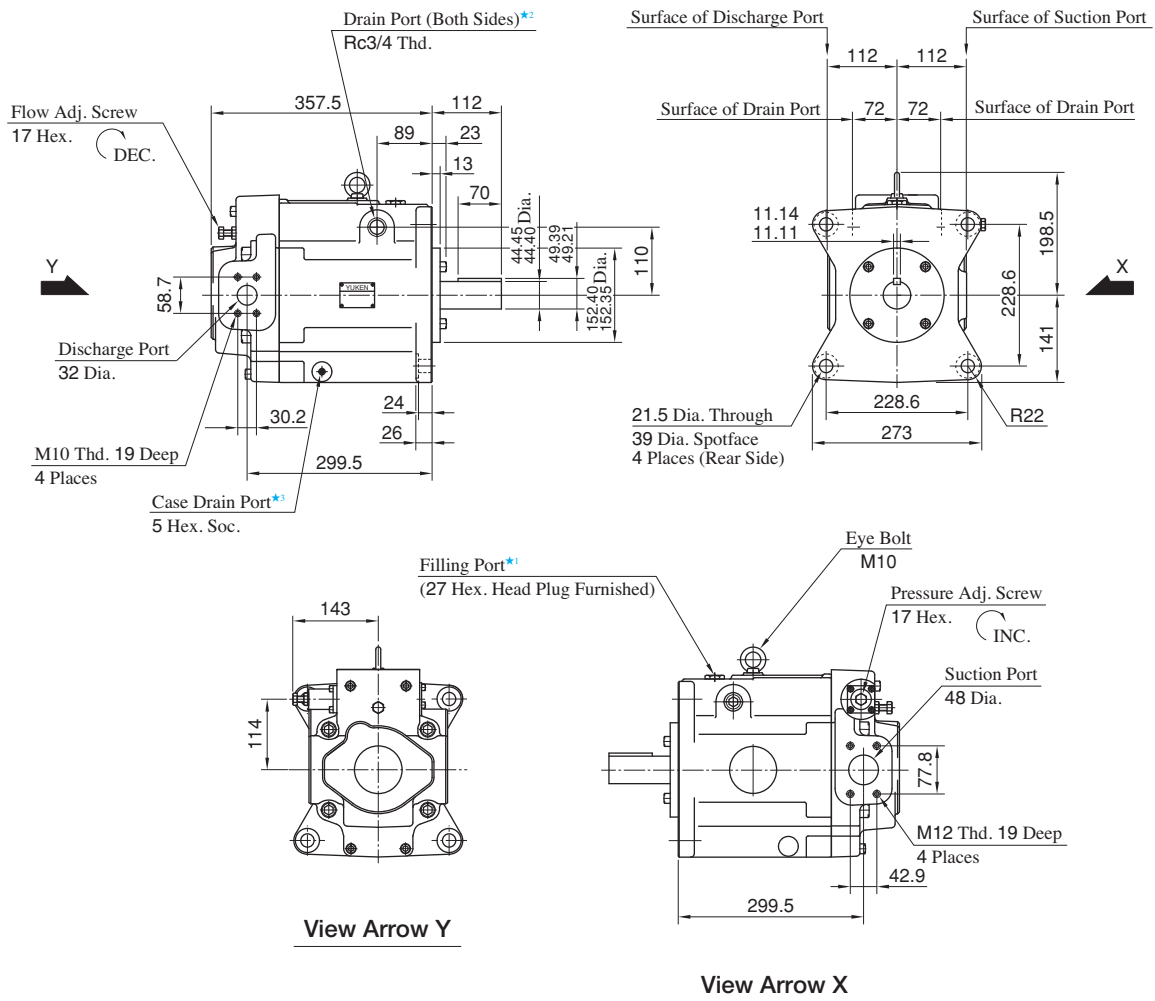

- ★1. Install the pump that the "Filling Port" is at the top.
- ★2. Use either port of the two drain port at your option. Keep the remaining port plugged.
- ★3. Case drain port is available for use when draining hydraulic fluid from pump casing.

Foot Mtg. : A145-LR01 * S

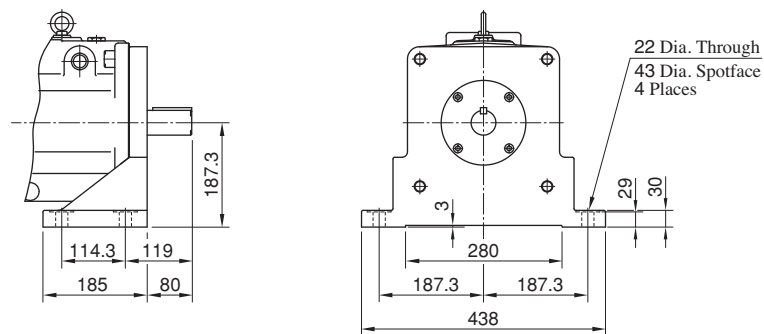

● For other dimensions, refer to "Flange Mtg."

Spare Parts List

A10-F-R-01

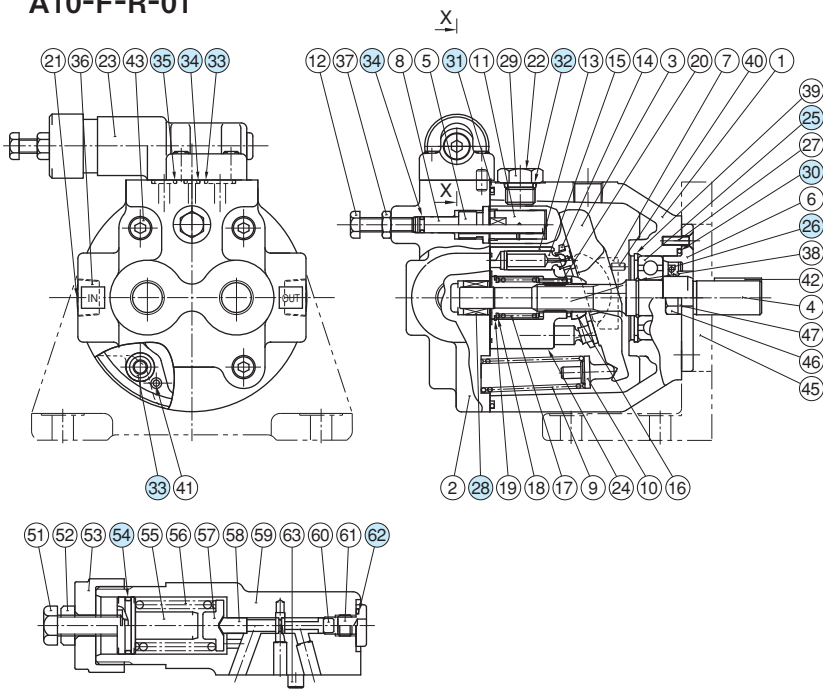

Section X-X

Item	Name of Parts	Part Numbers	Qty.
25	Bearing	6204	1
26	Oil Seal	TCN24408Y	1
28	Bearing	HMK1215	1
30	O-Ring	SO-NB-G50	1
31	O-Ring	SO-NB-G120	1
32	O-Ring	SO-NB-P14	1
33	O-Ring	SO-NB-P12	5
34	O-Ring	SO-NB-P6	2
35	O-Ring	SO-NB-P9★	1
54	O-Ring	AS568-018 (NBR-70)	1
62	O-Ring	SO-NB-P10	1

★O-Ring of Item 35 shall be SO-NB-P12 in case of A10-FR01-B.

A16/A22/A37/A56- *-R-01

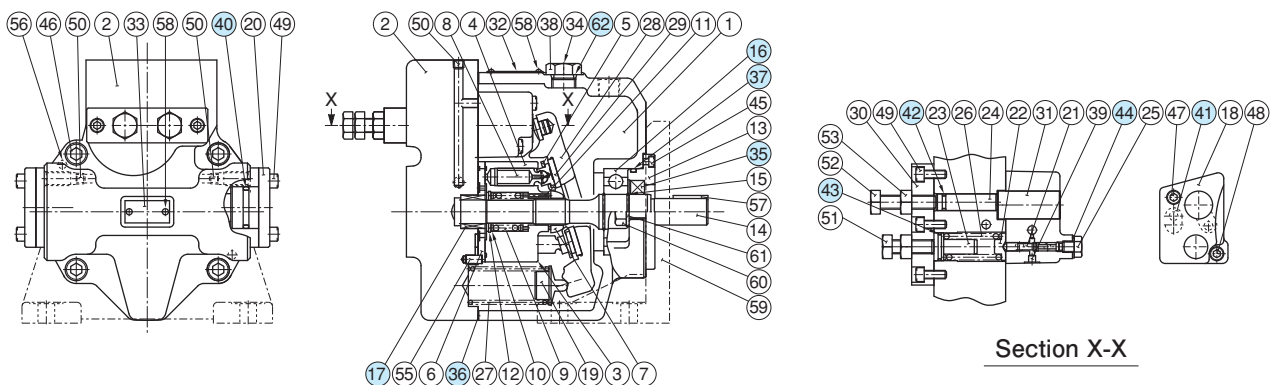

Section X-X

Item	Name of Parts	Part Numbers				Qty.
		A16- *-R-01	A22- *-R-01	A37- *-R-01	A56- *-R-01	
16	Bearing	6305		6307	NUP 207E	1
17	Bearing	HMK 1715	Z30-1303-PK410300-8	HMK 2025V2	HMK 2530V2	1
35	Oil Seal	TCN 254511		TCN 355511	TCN 355511	1
36	Gasket	130-PK211969-1		1316-PK211970-9	1307-PK21197-7	1
37	O-Ring	SO-NA-G55		SO-NA-G75		1
40	O-Ring	SO-NA-G25		SO-NA-G30	SO-NA-P36	2
41	O-Ring	SO-NB-P12		SO-NB-P10A		1
42	O-Ring	SO-NB-P9				1
43	O-Ring	AS568-017 (NBR-70)				1
44	Seal Washer	W8				1
62	O-Ring	SO-NB-P14				1

Spare Parts List

A70/A90/A100- *R01 * S

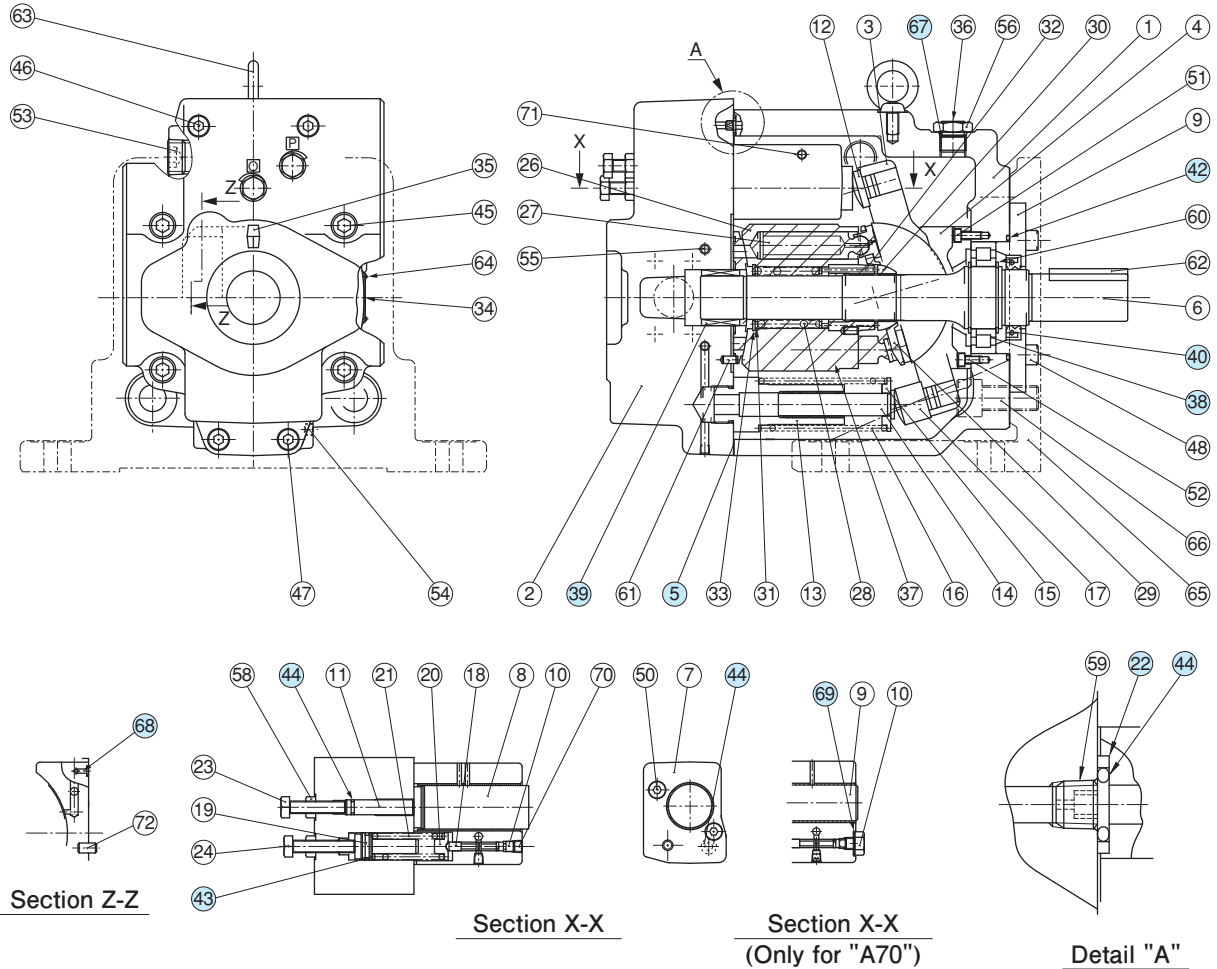

Item	Name of Parts	Part Numbers		Qty.
		A70- *R01 * S	A90- *R01 * S A100- *R01 * S	
5	Gasket	1314E-PK211972-5	1310E-PK211973-3	1
22	Back Up Ring	1310E-PK412440-0	1310E-PK412440-0	1
38	Bearing	NUP 208EX50	NUP 210E	1
39	Needle Bearing	HMK 3030V2	HMK 3530BV2	1
40	Oil Seal	TCN 355511 (FKM)	TCN 456812 (FKM)	1
42	O-Ring	SO-FA-G85	SO-FA-G95	1
43	O-Ring	SO-NA-P18	SO-NA-P18	1
44	O-Ring	SO-NB-P9	SO-NB-P9	3
67	O-Ring	SO-NB-P14	SO-NB-P18	1
68	O-Ring	SO-NB-P5	SO-NB-P5	1
69	Seal Washer	W10	—	1