

■ MOUNTING FLANGES

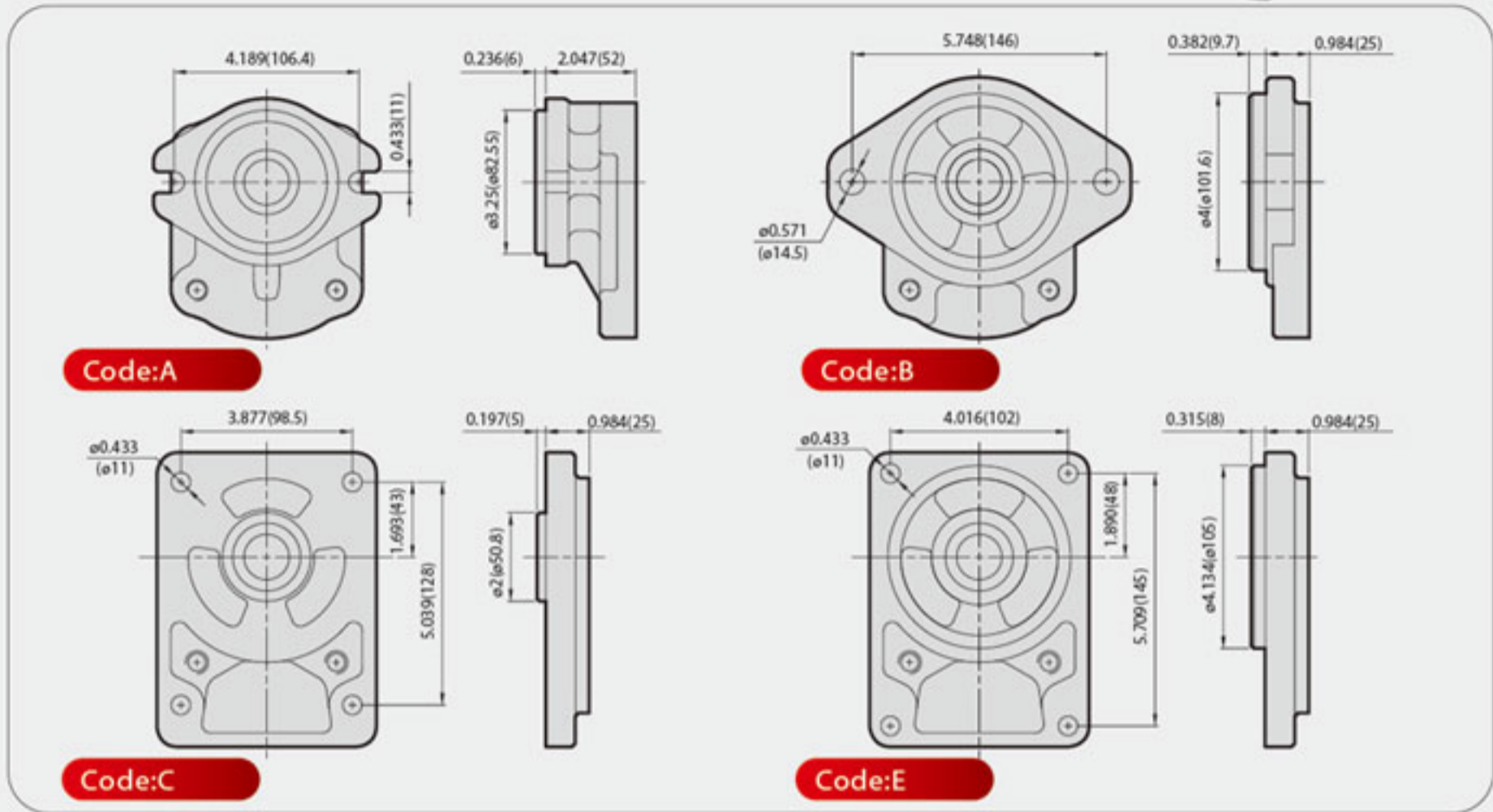

■ PORTS

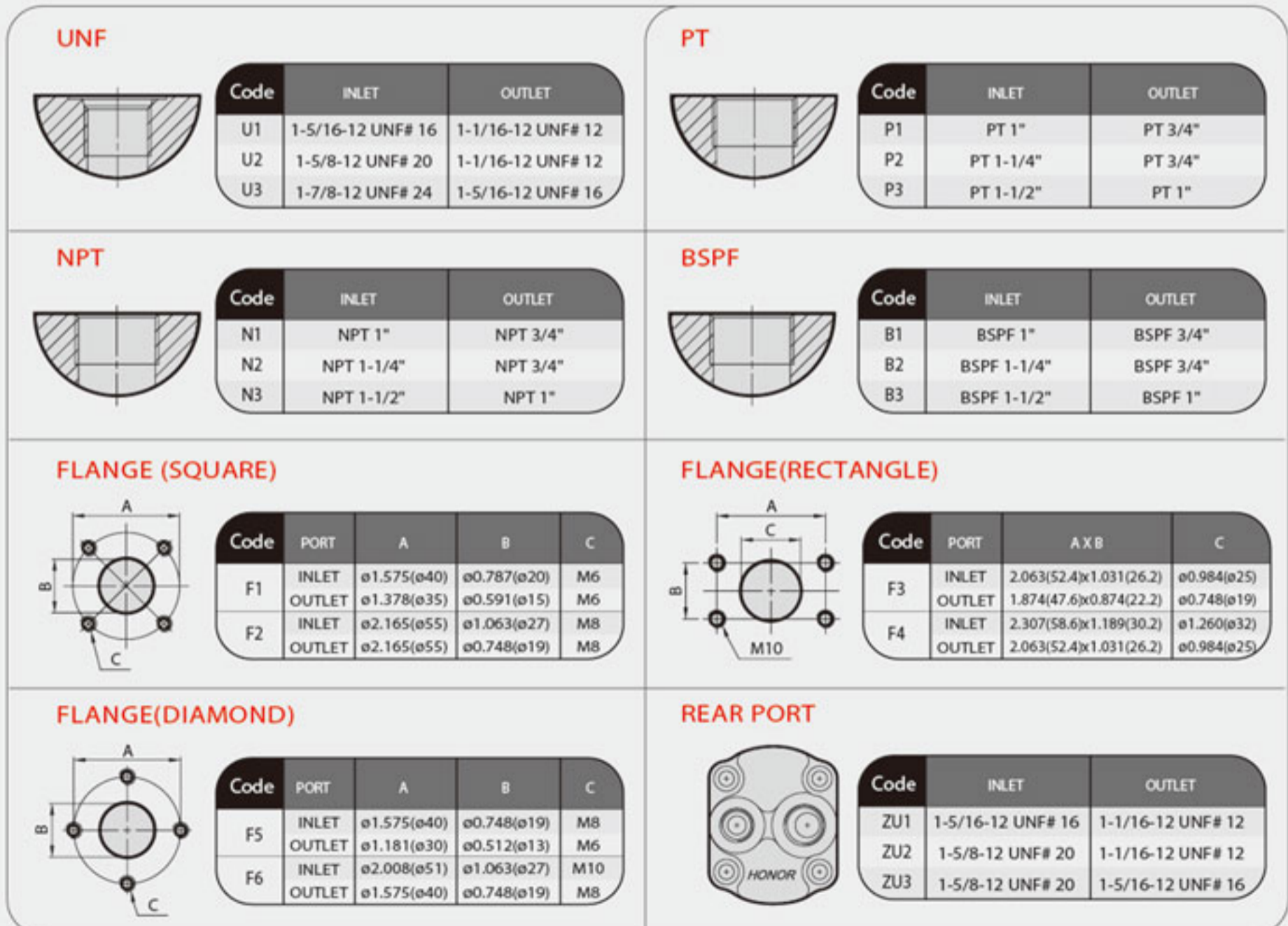

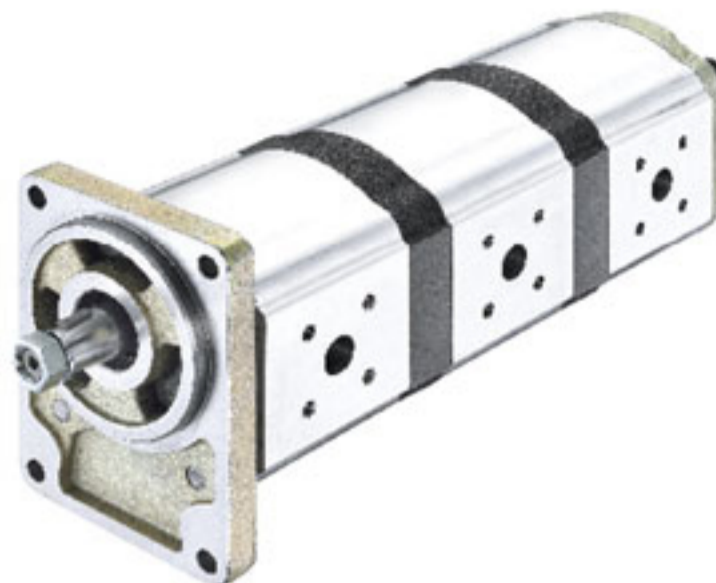

ORDERING EXAMPLE

3	□	B	6	B	U1U1U1	□	□	□	R
SERIES	TYPE	MOUNTING FLANGE	DRIVE SHAFT	INLET/OUTLET CODE	PORT (Front/Center/Rear)	DISPLACEMENT			R: CW L: CCW
D: Double Pumps T: Multiple Pumps				A: Common Inlet (Double Pump only) B: Separate Inlet					

If you need double pumps with front pump displ. 2.31 c.i.r \ rear pump 1.70 c.i.r and rotation is cw \ the model number is :

3DB6BU2U13828R

OVERALL DIMENSIONS

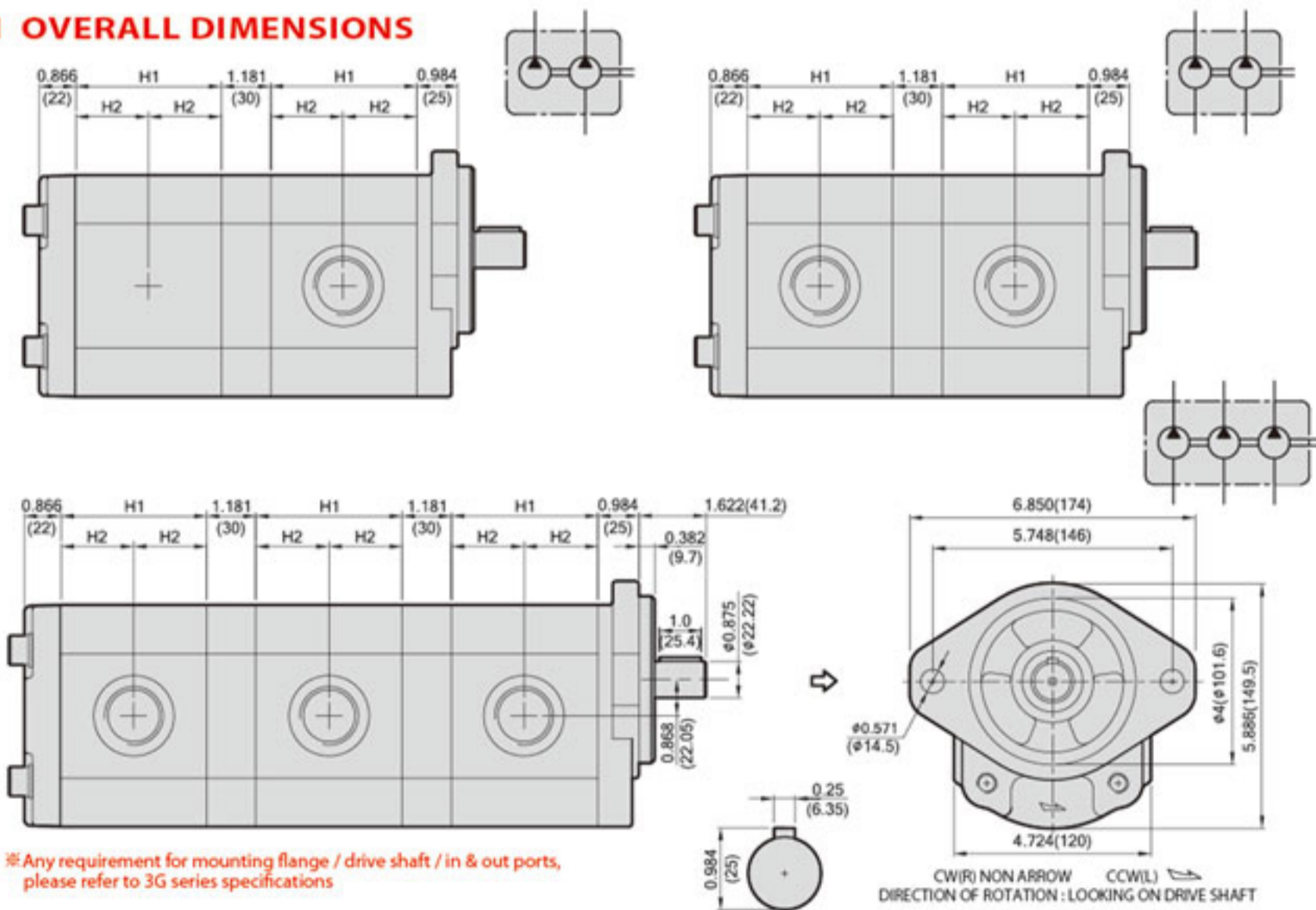

※ Any requirement for mounting flange / drive shaft / in & out ports, please refer to 3G series specifications

GROUP 3 PUMP

MODEL	18	20	23	25	28	33	38	44	52
c.i.r	1.10	1.22	1.40	1.52	1.70	2.01	2.31	2.68	3.17
cm ³ /r	18.0	20.0	23.0	25.0	28.0	33.0	38.0	44.0	52.0
H1	3.110(79)	3.150(80)	3.189(81)	3.268(83)	3.346(85)	3.504(89)	3.661(93)	3.819(97)	4.016(102)
H2	1.555(39.5)	1.575(40)	1.594(40.5)	1.634(41.5)	1.673(42.5)	1.752(44.5)	1.831(46.5)	1.909(48.5)	2.008(51)

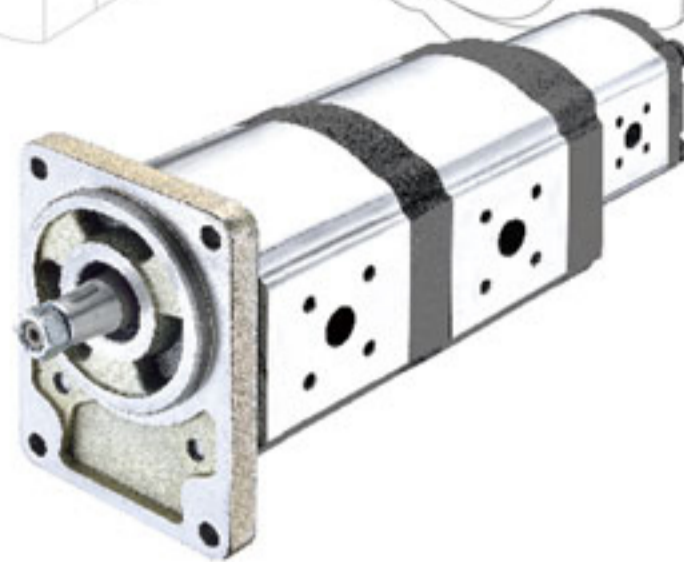

ORDERING EXAMPLE

32	□	B	6	B	U1U1	□	□	□	R
SERIES	TYPE	MOUNTING FLANGE	DRIVE SHAFT	INLET/OUTLET CODE	PORT (Front/Centered)	DISPLACEMENT			R: CW L: CCW
D: Double Pumps T: Multiple Pumps		B: Separate Inlet							

If you need multiple pumps with front pump displ. 2.31 c.i.r \ center pump 1.70 c.i.r \ rear pump 0.85 c.i.r and rotation is cw
 \ the model number is : **32TB6BU2U1382814R**

OVERALL DIMENSIONS

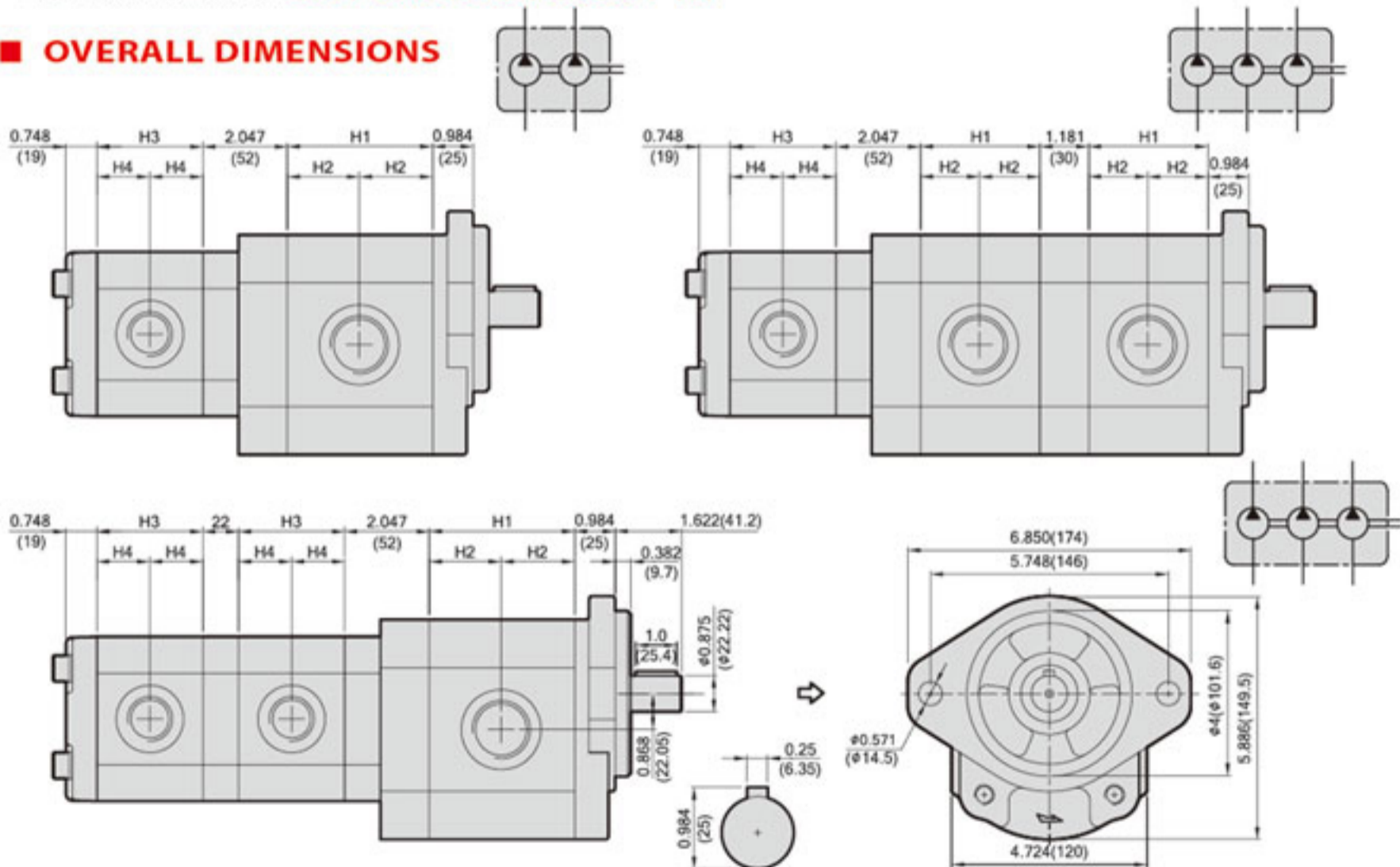

* Any requirement for mounting flange / drive shaft / in & out ports, please refer to 3G series specifications

CW(R) NON ARROW CCW(L) DIRECTION OF ROTATION : LOOKING ON DRIVE SHAFT

GROUP 2 REAR PUMP COMBINATION

MODEL	06	07	08	09	11	14	16	18	20	22
c.i.r	0.38	0.43	0.52	0.58	0.69	0.85	0.98	1.10	1.20	1.31
cm ³ /r	6.2	7.0	8.4	9.5	11.3	14.0	16.0	18.0	19.5	21.5
H3	1.949(49.5)	2.008(51)	2.106(53.5)	2.165(55)	2.283(58)	2.441(62)	2.559(65)	2.677(68)	2.835(72)	2.874(73)
H4	0.976(24.8)	1.004(25.5)	1.055(26.8)	1.083(27.5)	1.142(29)	1.220(31)	1.280(32.5)	1.339(34)	1.417(36)	1.437(36.5)

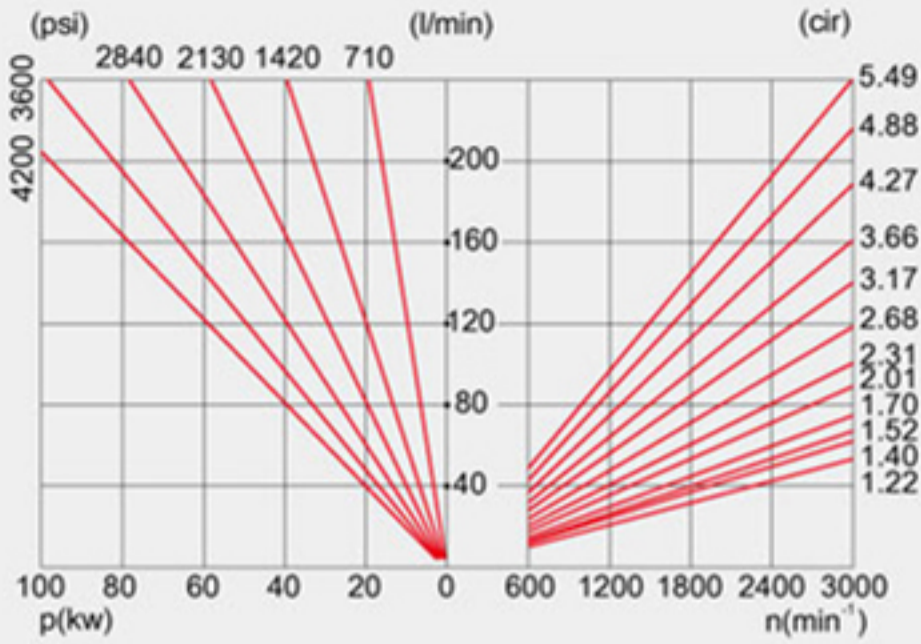

GROUP 3

3G/3D/3T SERIES PERFORMANCE CURVE

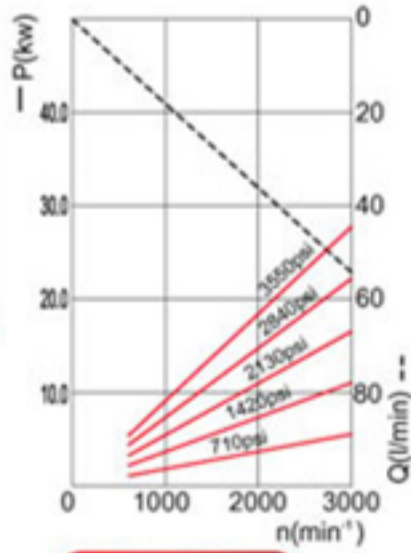

MODEL:20

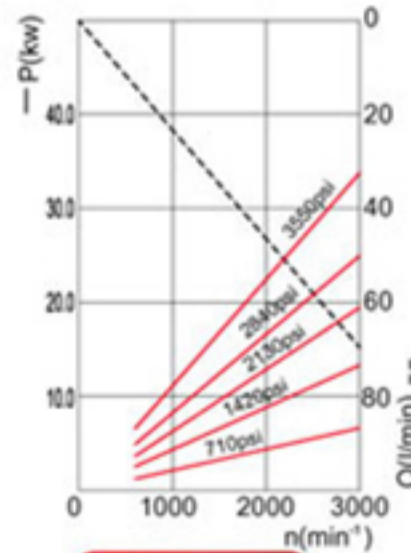

MODEL:23

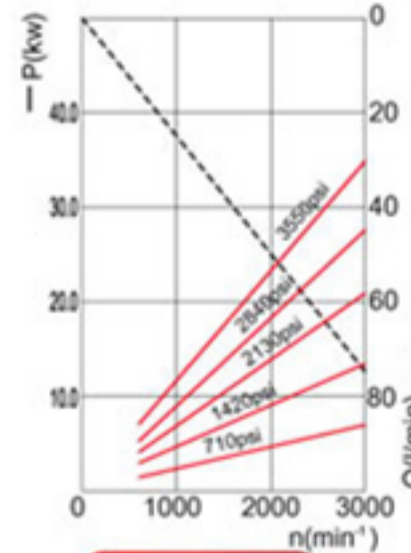

MODEL:25

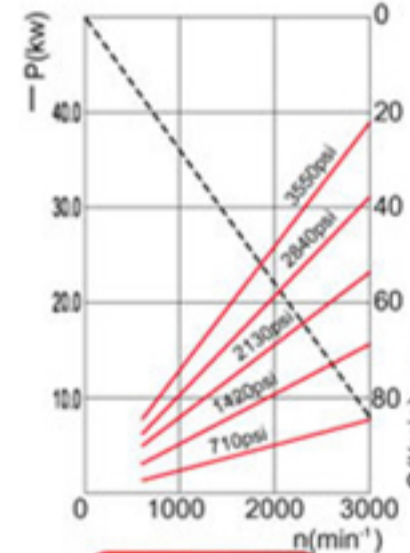

MODEL:28

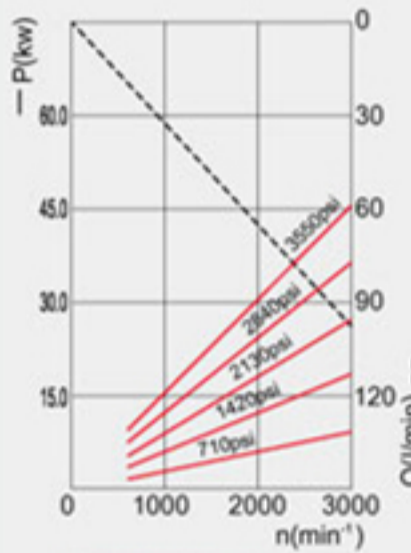

MODEL:33

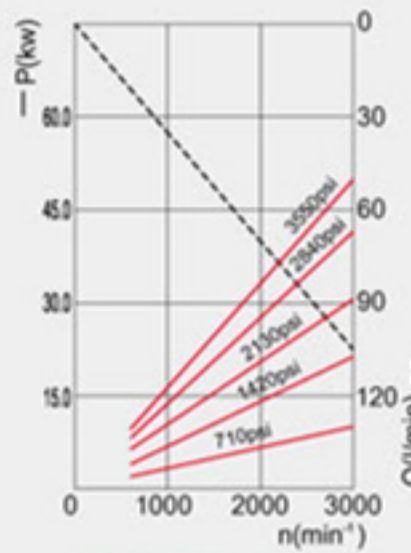

MODEL:38

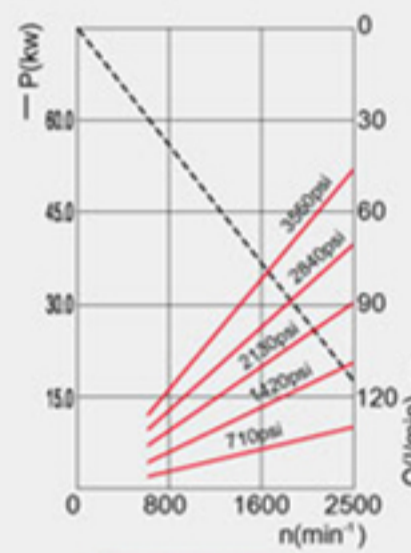

MODEL:44

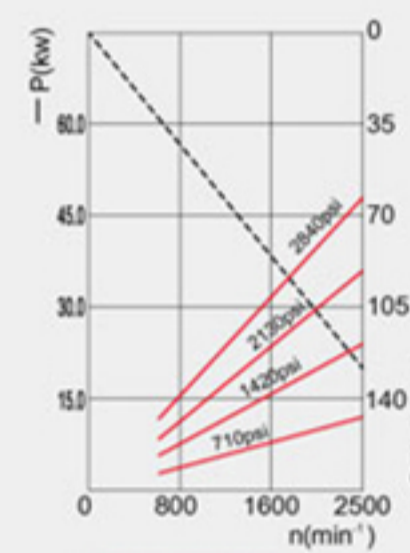

MODEL:52

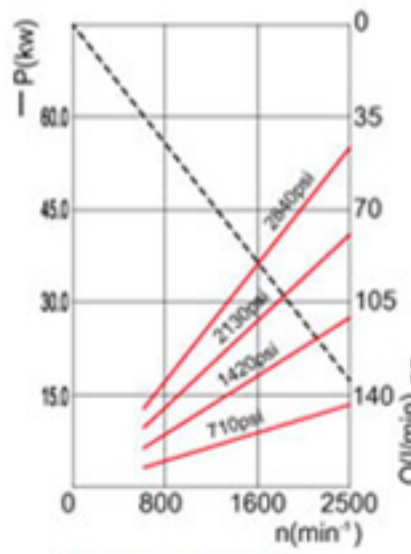

MODEL:60

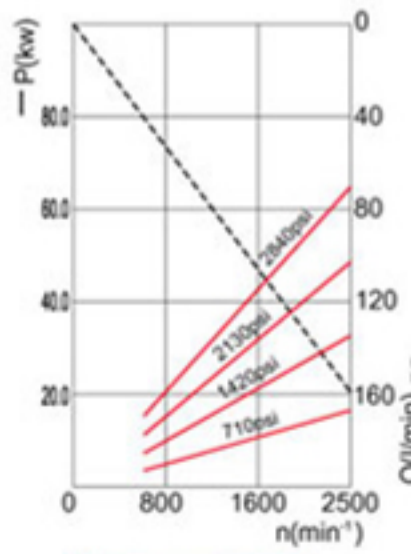

MODEL:70

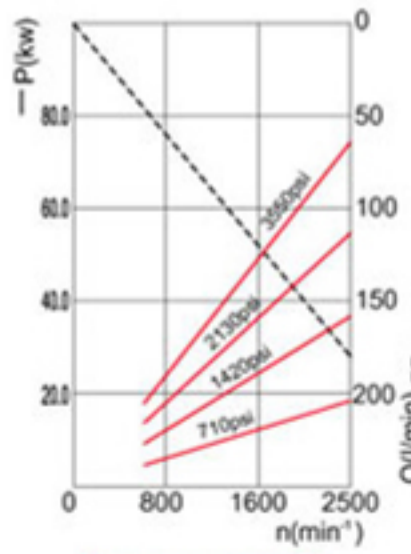

MODEL:80

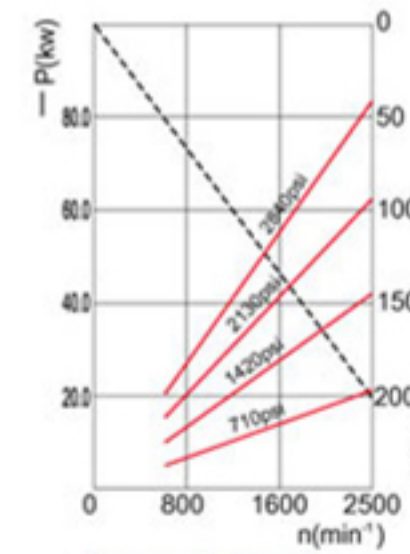

MODEL:90

HONOR

Sole Agent / Authorized Distributor

• HONOR PUMPS U.S.A.

222 S. NAVIGATION BLVD., CORPUS CHRISTI, TEXAS, 78405, USA
TEL: +1-800-984 9727 | FAX: +1-713-461 9631 | E-mail: service@honorpumps.com
<http://www.honorpumps.com>

• SOUTHERN FLUID POWER CANADA

100 FERNSTAFF COURT, UNIT 1, VAUGHAN, ONTARIO, L4K 3L9
TEL: +1-905-760-5546 | FAX: +1-905-760-0685 | E-mail: larry@southernfluidpower.net
<http://www.southernfluidpower.ca>

• PT. TIARA ABADI NUSANTARA JAYA INDONESIA

JL. RAYA DUPAK 63 KAV. E10, SURABAYA, 60172 (KOMPLEK PERTOKOAN MUTIARA DUPAK)
TEL: +62-3153 52104 | FAX: +62-3153 52094 | E-mail: pt.tanj@gmail.com

• NINGBO HONOR INTERNATIONAL TRADING CO., LTD. CHINA

BLDG.4, NO.8 CHUANGYE 3 ROAD, FREE TRADE WEST ZONE, NINGBO.
TEL: +86-574-8689 5161 | FAX: +86-574-8689 5163 | E-mail: honor2@jm-best.com

• JMEC HONOR VIETNAM COMPANY LIMITED

Số nhà 6, Ngách 91/16, Ngõ 91 đường Trần Duy Hưng, phường Trung Hòa, quận Cầu Giấy, TP. Hà Nội, Việt Nam.
TEL: +84-432-000-216 | FAX: +84-432-000-225 | E-mail: honor_hanoi@honorpump.com.tw

• FUTECH ENGINEERING TRADING COMPANY LIMITED

G/F., 123C TIN HA ROAD, HUNG SHUI KIU, YUEN LONG, NEW TERRITORIES, HONG KONG
TEL: +852-3118 1665 | FAX: +852-3118 6557 | E-mail: sales@chinahydraulic.com
<http://futechengineering.com>

Headquarters / Factory

• HONOR GEAR PUMPS CORP. TAIWAN

NO.190, CHENG KUNG 3 ROAD, NAN KANG INDUSTRY PARK, NAN TOU CITY, 54066, TAIWAN.
TEL: +886-49-225 0421 | FAX: +886-49-225 7894 | E-mail: service@honorpump.com.tw
<http://www.honorpump.com.tw>

Warranty Statement

HONOR Gear Pumps Corp. products are warranted for 12 months from date of shipment from HONOR Taiwan or our authorized sales agents worldwide, to be free from defects in material and workmanship under correct use, normal operating conditions, and proper application.

HONOR's obligation under this warranty is limited to repair or exchange, at Honor's option, of any HONOR product or part which proves to be defective as provided herein.

Warranty consideration will only be extended upon return of the product to HONOR or Honor's authorized sales agents, for inspection, and then only if authorization to return has been given prior to the return.

Warranty will not extend to product damaged by accident, abuse, misuse, or misapplication, nor to goods altered or repaired by other than HONOR.



HR1606

graphic design / DAY YEU E-mail: winart@winart.com.tw
C00771-150915-020